

PURIFYING LIFETIME QUALITY



EQUIPPED
AMONG
EASE

UROLOGY+



VORLING
instruments

HAS THE REPUTATION OF BEING THE ONLY IN PAKISTAN THAT MANUFACTURES ITS OWN TOOLS FOR THE PRODUCTION OF ITS INSTRUMENTS.

An Era Of **evolution**

VORLING instruments is a privately owned company providing personalized services and the finest in Surgical Instruments for over 25 years. Established in 1999, Our Company manufactures a wide range of Surgical, Dental and Veterinary Instruments.

All Instruments and devices of our product range are manufactured by well-trained and experienced skilled workers with special craftsmanship and by use of most modern machines and equipment. On this occasion we only use materials which meet our high standards. The CEO of Vorling Instruments, Mr. Muhammad Ahmed brings with him a lifetime of knowledge about the world of surgical instruments.

This insight allows us to understand the needs of our customers in a way most other instrument companies are unable to do.

After becoming a competent oem service provider, cardiac has decided to introduce itself as the original source of high quality instrumentation to directly interact with some of the well-known brands around the world.

Kidney Stone Forceps
 Nierensteinzangen
 Pinzas para cálculos renales
 Pincas pour les calculs du bassin
 Pinze per calcoli renali



1/2

Randall
V18-101-23
V18-101-18

1/4

Fig. 1
V18-101-23
 23 cm / 9"

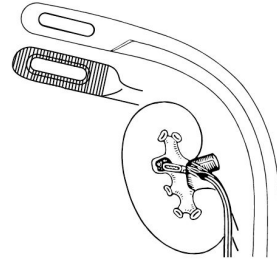
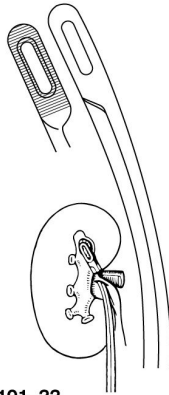

Fig. 2
V18-101-21
 21 cm / 8 2/8"

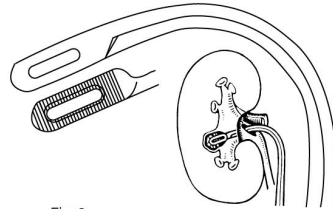

Fig. 3
V18-101-19
 19 cm / 7 4/8"

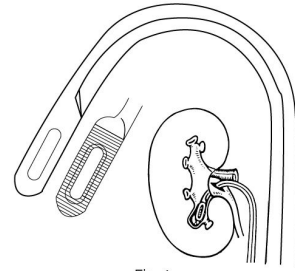

Fig. 4
V18-101-18
 18,5 cm / 7 2/8"



1/2

Heiming
V18-102-16
V18-102-17

für Kinder
 for children
 para niños
 pour enfants
 per bambini

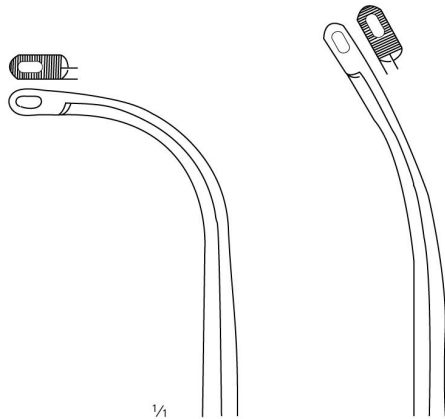

1/4

Fig. 1
V18-102-16
 16 cm / 6 2/8"

Fig. 2
V18-102-17
 17 cm / 6 5/8"

Gall Duct Dilators

Gallenkanaldilatatore
 Dilatadores para conducto biliar
 Dilatateurs pour les voies biliaires
 Dilatatori per condotti biliari



1/2

Bakes

V18-103-01

V18-103-13

32 cm / 12 5/8"

biegsamer Schaft
 malleable shaft
 vástago maleable
 tige malléable
 gambo malleabile



Fig. 1	Fig. 2	Fig. 3	Fig. 4
Ø 1,0 mm	Ø 2,0 mm	Ø 3,0 mm	Ø 4,0 mm
V18-103-01	V18-103-02	V18-103-03	V18-103-04

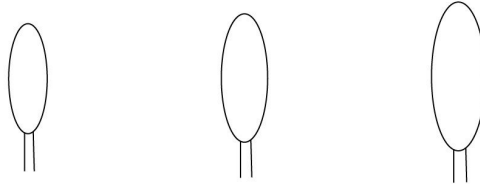

Fig. 5	Fig. 6	Fig. 7
Ø 5,0 mm	Ø 6,0 mm	Ø 7,0 mm
V18-103-05	V18-103-06	V18-103-07

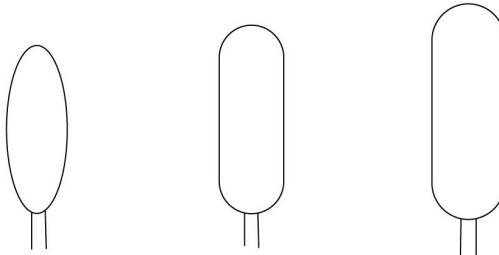

Fig. 8	Fig. 9	Fig. 10
Ø 8,0 mm	Ø 9,0 mm	Ø 10 mm
V18-103-08	V18-103-09	V18-103-10

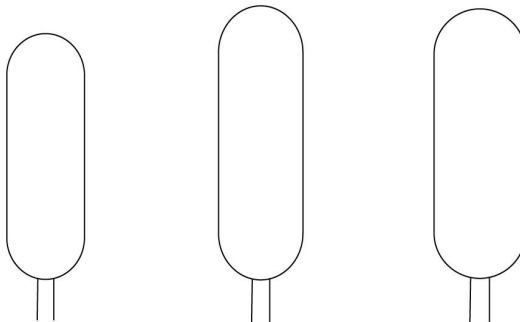

Fig. 11	Fig. 12	Fig. 13
Ø 11 mm	Ø 12 mm	Ø 13 mm
V18-103-11	V18-103-12	V18-103-13



Gall Stone Forceps

Gallensteinzangen
Pinzas para cálculos biliares
Pinces pour calculs biliaires
Pinze per calcoli biliari



V18-104-21
21 cm / 8 2/8"

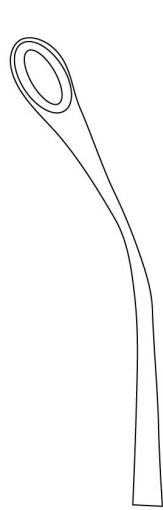

V18-104-20
20,5 cm / 8 1/8"



Mayo-Blake
V18-105-21
21 cm / 8 2/8"



Mayo-Blake
V18-106-21
21 cm / 8 2/8"

Gall Stone Forceps

Gallensteinzangen
Pinzas para cálculos biliares
Pincès pour calculs biliaires
Pinze per calcoli biliari



Mixer
V18-107-22
22 cm / 8 5/8"



Desjardins
V18-108-23
V18-109-23
23 cm / 9"

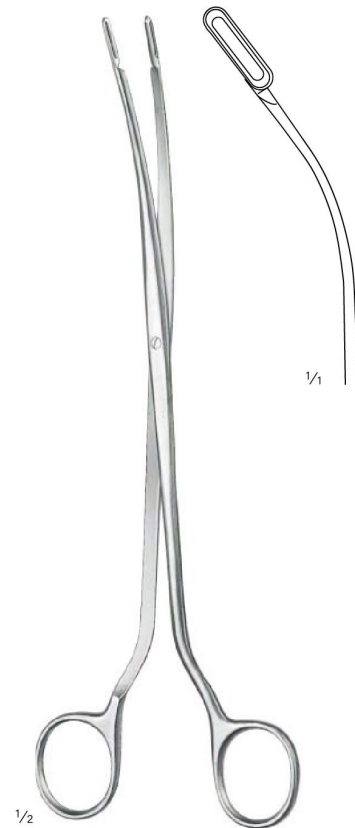

Desjardins
V18-110-22
22,5 cm / 8 7/8"



Gall Stone Scoops

Gallensteinlöffel
Cucharas para cálculos biliares
Curettes pour calculs biliaires
Pinze per calcoli biliari



1/4

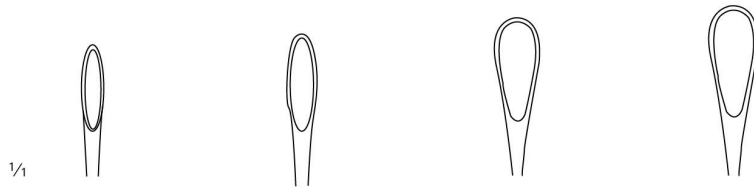

1/4

Fig. 000	Fig. 00	Fig. 0	Fig. 1
2,7 mm	3,4 mm	4,3 mm	5,5 mm
V18-111-01	V18-111-02	V18-111-03	V18-111-04

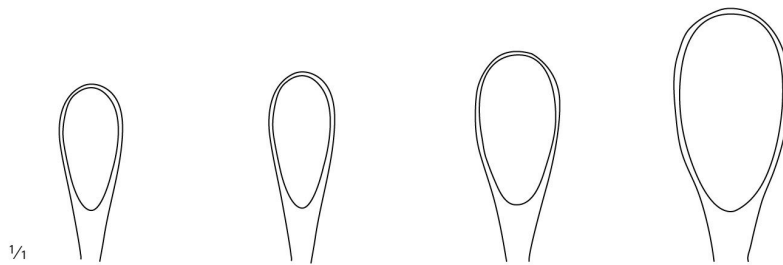

1/4

Fig. 2	Fig. 3	Fig. 4	Fig. 5
6,6 mm	8 mm	11 mm	15 mm
V18-111-05	V18-111-06	V18-111-07	V18-111-08

1/2

Luer-Körte

V18-111-01

V18-111-08

32 cm / 12 5/8"

biegsamer Schaft, stumpf
malleable shaft, blunt
vástago maleable, romo
tige malléable, mousse
gambo malleabile, smusso



Prostatic Retractors

Prostatahaken
Separadores para próstata
Ecarteurs prostatiques
Divaricatori prostatici

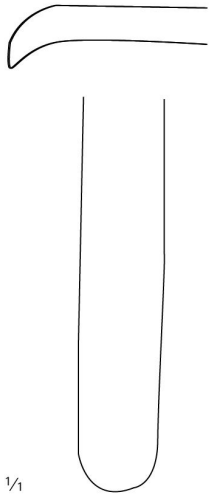

1/1

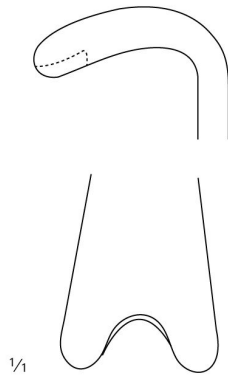

1/1

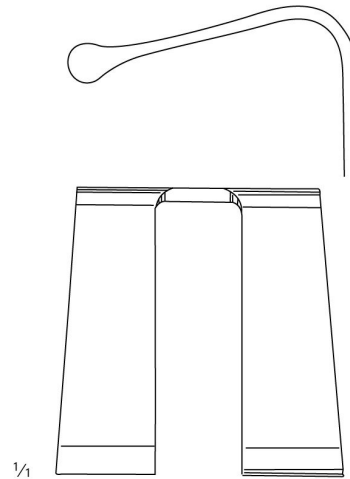

1/1



1/2

12,5 mm

Young

V18-112-22

22 cm / 8 5/8"



1/2

24 mm

Young

V18-113-22

22 cm / 8 4/8"



1/2

41 mm

Young

V18-114-23

23 cm / 9"



Capsule Forceps
Kapsel­fass­zangen
Pinzas capsulares
Pinces pour saisir les capsules
Pinze per afferrare capsule

Atrauma



Millin
V18-115-24
24,5 cm / 9 5/8"

Atrauma



Millin
V18-116-22
22,5 cm / 8 7/8"

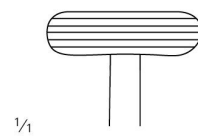

Millin
V18-117-24
24,5 cm / 9 5/8"

Capsule Forceps, Ligature Carrying Forceps

Kapselfasszange, Fadenführungszange
Pinzas capsulares, Pinza porta ligaduras
Pincers pour saisir les capsules, Pince porte-fil
Pinze per afferrare capsule, Pinza porta-filo



Millin
V18-118-22
22 cm / 8 5/8"



Millin
V18-119-24
24 cm / 9 4/8"

Bladder Neck Spreader, Bladder Retractors

Blasenhalsperrer, Blasenwundsperrer
Dilatador para el cuello vesical, Separadores vesicales
Ecarteur pour le col de la vessie, Ecarteurs vésicaux
Divaricatore del collo vescicale, Divaricatore vescicale



1/2

Millin
V18-120-28
28 cm / 11"



70 mm



1/2

Judd-Masson
V18-121-00



120 mm



Bladder Retractors
 Blasenwundsperrer
 Separadores vesicales
 Ecarteurs vésicaux
 Divaricatore vescicale



1/2

Millin

V18-122-00

komplett, mit je 2 Seitenvalven
 57 x 25 mm und 80 x 25 mm, sowie
 einer 1 Mittelvalve 120 x 45 mm

complete, with 2 pairs of lateral
 blades 57 x 25 mm and 80 x 25 mm,
 and 1 central blade 120 x 45 mm

completo, con 2 pares de valvas
 laterales 57 x 25 mm y 80 x 25 mm y
 una valva central 120 x 45 mm,

complet, avec 2 paires de valvas
 latérales 57 x 25 mm et 80 x 25 mm
 et 1 valve centrale 120 x 45 mm,

completo, con 2 paia di valve laterali
 57 x 25 mm e 80 x 25 mm in più 1
 valva centrale 120 x 45 mm,



57 x 25 mm
V18-122-90-98
 Seitenvalven
 Lateral Blades
 Valvas laterales
 Valves laterales
 Valve laterali



80 x 25 mm
V18-122-91-98
 Seitenvalven
 Lateral Blades
 Valvas laterales
 Valves laterales
 Valve laterali

120 x 45 mm
V18-122-92-98
 Mittelvalve
 Central Blade
 Valva central
 Valve centrale
 Valva centrale





Charrière	Van Buren
8	V18-123-08
10	V18-123-10
12	V18-123-12
14	V18-123-14
16	V18-123-16
18	V18-123-18
20	V18-123-20
22	V18-123-22
24	V18-123-24
26	V18-123-26
28	V18-123-28
30	V18-123-30
32	V18-123-32
34	V18-123-34
36	V18-123-36

1/2

Van Buren
V18-123-08
V18-123-36
 27 cm / 10 5/8"

V18-123-00
 Satz komplett, 8 - 36 Charrière
 complete set, 8 - 36 Charrière
 juego completo, 8 - 36 Charrière
 jeu complet, 8 - 36 Charrière
 set completo, 8 - 36 Charrière



1/2

Guyon
V18-124-10
V18-124-30
 26,5 cm / 10 3/8"

Charrière	Guyon
10	V18-124-10
11	V18-124-11
12	V18-124-12
13	V18-124-13
14	V18-124-14
15	V18-124-15
16	V18-124-16
17	V18-124-17
18	V18-124-18
19	V18-124-19
20	V18-124-20
21	V18-124-21
22	V18-124-22
23	V18-124-23
24	V18-124-24
25	V18-124-25
26	V18-124-26
27	V18-124-27
28	V18-124-28
29	V18-124-29
30	V18-124-30



Catheters
Katheter
Sondas
Sondes
Sonde

Charrière	
13	V18-125-13
15	V18-125-15



V18-125-13

V18-125-15

15 cm / 5 7/8"

Metallkatheter für Frauen
Metal Catheters, female
Sondas metálicas, femeninas
Sondes métalliques, pour femmes
Sonde metalliche, per donne



Urethrotome
 Urethrotom
 Uretrótopo
 Urétrótome
 Uretrotomi

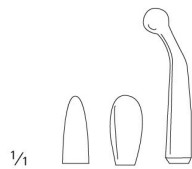

1/1

V18-126-90-98

3 Ansätze allein
 3 tips only
 3 puntas suelta
 3 embouts seul
 3 punte solo



Otis

V18-126-00

komplett im Holzetui, mit Dilatator, 2 Messern und 3 Ansätzen
 complete in wooden case, with dilator, 2 knives and 3 tips
 completo en caja de madera, con dilatador, 2 cuchillos y 3 puntas
 complet en boîte de bois, avec dilateur, 2 lames et 3 embouts
 completo in contenitore di legno, con dilatatore, 2 bisturi e 3 punte



1/2



1/2

Otis

V18-127-00

Ersatzmesser
 Spare Blade
 Cuchillo de repuesto
 Couteau de rechange
 Lama di ricambio

➔ **V18-126-00**



1/2

Knutson
V18-128-00

Urethrographieinstrument
 Urethrography Instrument
 Instrumento para uretrografia
 Instrument pour urétrographie
 Strumento per uretrografia



1/2

Knutson-Koch
V18-129-00

Konus, allein
 Cone, only
 Cono, suelto
 Cône, seul
 Cono, solo

➔ V18-128-00



1/2

V18-130-08
V18-130-32

Circumcisionsgerät
 Circumcision Instrument
 Instrumento para circuncisión
 Instrument de circoncision
 Strumento per circoncisione

	Ø
V18-130-08	8 mm
V18-130-11	11 mm
V18-130-13	13 mm
V18-130-16	16 mm
V18-130-21	21 mm
V18-130-26	26 mm
V18-130-32	32 mm



1/2

Mogen
V18-131-00

7,5 cm / 3 "
 Beschneidungsinstrument
 Circumcision Instrument
 Instrumento para circuncisión
 Instrument de circoncision
 Strumento per circoncisione



Foreign Body Forceps
 Fremdkörperzangen
 Pinzas para cuerpos extraños
 Pinces pour corps étrangers
 Pinze per corpi estranei

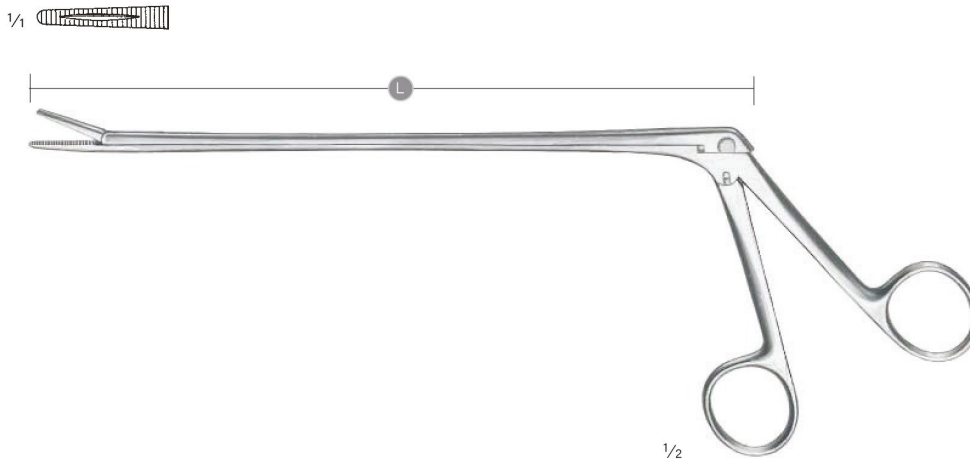

Mathieu
V18-132-20

Schaftlänge
 shaft length
 longitud del vástago
 longueur de la tige
 lunghezza dell'asta
 200 mm

Mathieu
V18-132-28

Schaftlänge
 shaft length
 longitud del vástago
 longueur de la tige
 lunghezza dell'asta
 300 mm

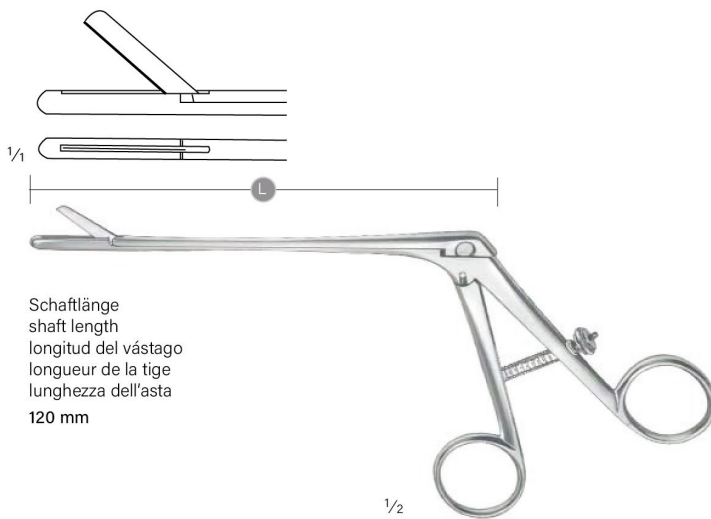

Schaftlänge
 shaft length
 longitud del vástago
 longueur de la tige
 lunghezza dell'asta
 120 mm

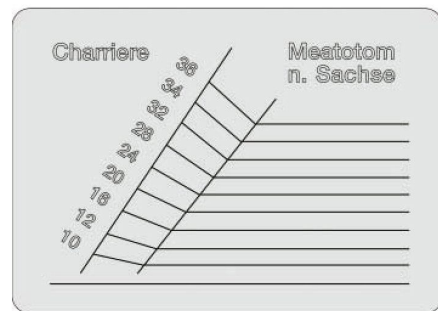

Sachse
V18-133-12

Meatotom
 Meatotome
 Meatótomo
 Méatotome
 Meatotomo

Sachse
V18-134-00

Messlehre
 Gauge
 Calibre
 Calibre
 Calibro



Penis Clamps

Penisklemmen
Clamps para pene
Pinces pour pénis
Serrapene



Stockmann
V18-135-08
8 cm / 3 1/8"



Strauss
V18-136-11
11 cm / 4 3/8"

V18-137-90-98

1 Paar Schläuche allein
1 pair of flexible tubes only
1 par de mangueras individuales
1 paire de tubes flexibles, seuls
1 coppia di tubi flessibili singoli



no one does it BETTER



Cell: +92 334 6113800

URL: <https://vorlinginstruments.com>

Email: info@vorlinginstruments.com

Address:

Kacha Shahab Pura Road

Jeewan Pura, Sialkot (51310)

Pakistan.

