

# BRIGHTENS CURE

• FACILITATES  
LIFE WALK

STOMACH +  
INTESTINES  
RECTUM

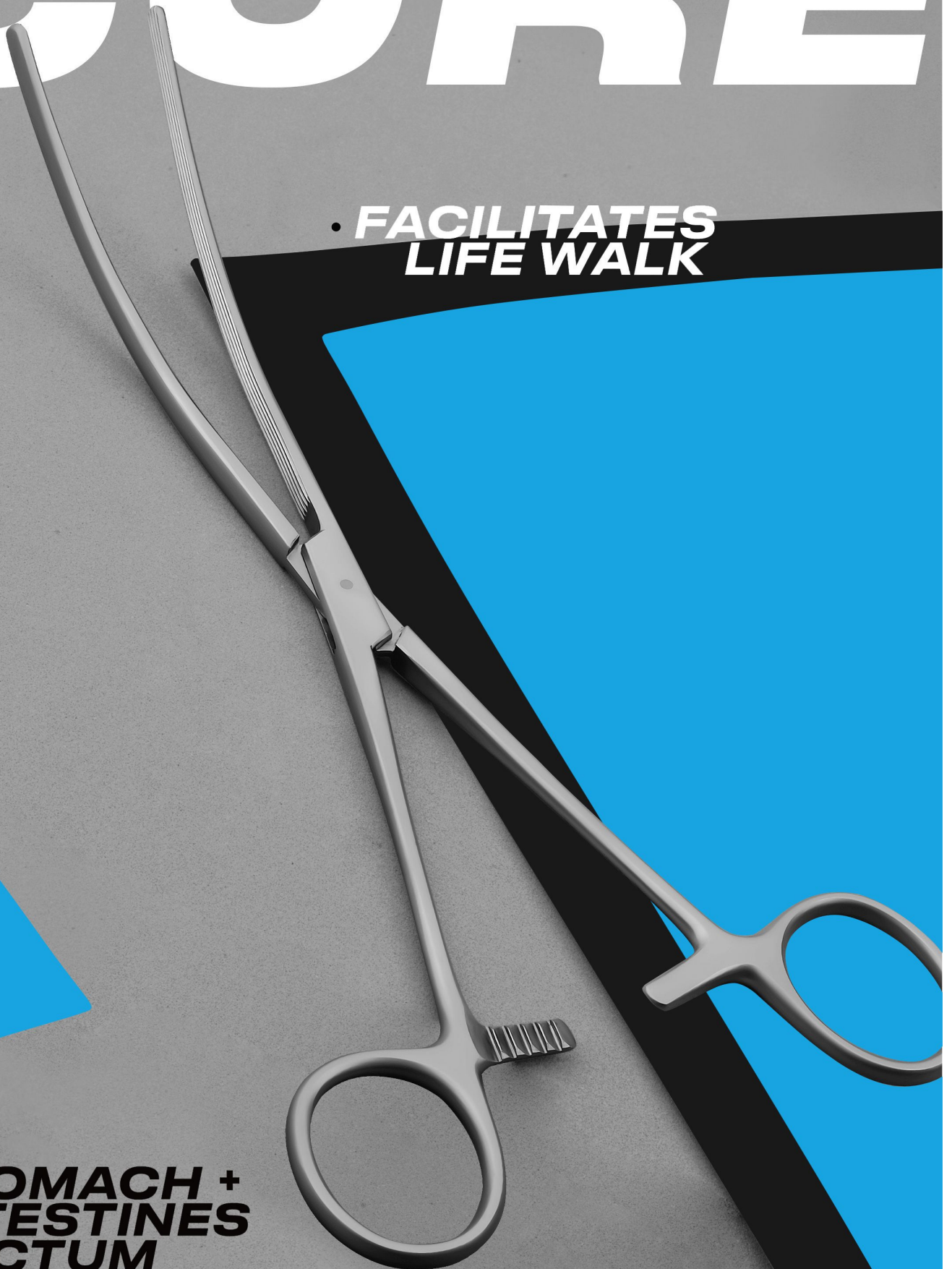



**VORLING**  
instruments

HAS THE REPUTATION OF BEING THE ONLY IN PAKISTAN THAT MANUFACTURES ITS OWN TOOLS FOR THE PRODUCTION OF ITS INSTRUMENTS.

## An Era Of **evolution**

---

**VORLING** instruments is a privately owned company providing personalized services and the finest in Surgical Instruments for over 25 years. Established in 1999, Our Company manufactures a wide range of Surgical, Dental and Veterinary Instruments.

All Instruments and devices of our product range are manufactured by well-trained and experienced skilled workers with special craftsmanship and by use of most modern machines and equipment. On this occasion we only use materials which meet our high standards. The CEO of Vorling Instruments, Mr. Muhammad Ahmed brings with him a lifetime of knowledge about the world of surgical instruments.

---

This insight allows us to understand the needs of our customers in a way most other instrument companies are unable to do.

**After becoming a competent oem service provider, cardiac has decided to introduce itself as the original source of high quality instrumentation to directly interact with some of the well-known brands around the world.**

---

**Intestinal and Tissue Grasping Forceps**

Darm- und Gewebefasszangen  
 Pinzas para intestinos y tejidos  
 Pinces pour saisir intestins et tissus  
 Pinze per afferrare intestino e tessuti



**Allis-Baby**  
**V17-100-13**  
 13 cm / 5 1/8"



**Allis**  
**V17-101-15**  
**V17-104-25**

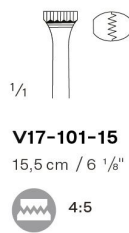

**V17-101-15**  
 15,5 cm / 6 1/8"



**V17-102-15**  
 15,5 cm / 6 1/8"

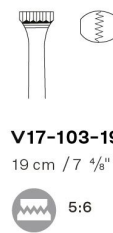

**V17-103-19**  
 19 cm / 7 4/8"



**V17-104-25**  
 25,5 cm / 10"

**Atrauma**



**Allis**  
**V17-105-15**  
**V17-105-30**

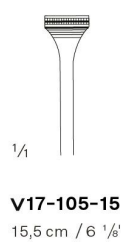

**V17-105-15**  
 15,5 cm / 6 1/8"

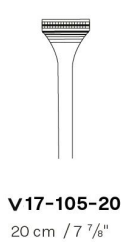

**V17-105-20**  
 20 cm / 7 7/8"

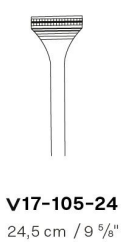

**V17-105-24**  
 24,5 cm / 9 5/8"

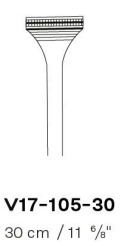

**V17-105-30**  
 30 cm / 11 5/8"

**Intestinal and Tissue Grasping Forceps**

Darm- und Gewebefasszangen  
Pinzas para intestinos y tejidos  
Pincas pour saisir intestins et tissus  
Pinze per afferrare intestino e tessuti



**Allis-Adair**  
**V17-106-16**  
16 cm / 6 2/8"



**Boys-Allis**  
**V17-107-15**  
15,5 cm / 6"

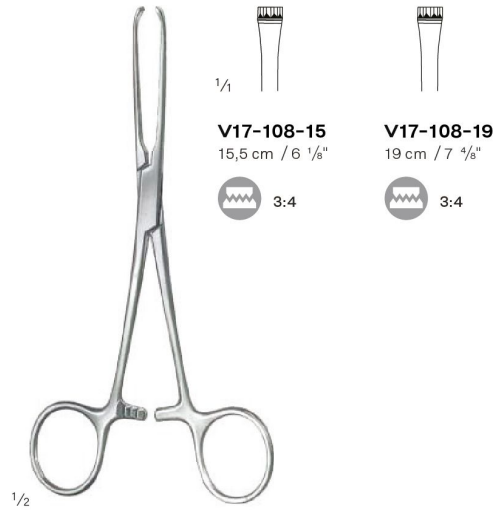

**Judd-Allis**  
**V17-108-15**  
15,5 cm / 6 1/8"  
**V17-108-19**  
19 cm / 7 1/8"



**Thoms-Allis**  
**V17-109-20**  
20,5 cm / 8 1/8"



**Allis**  
**V17-110-20**  
20 cm / 7 7/8"

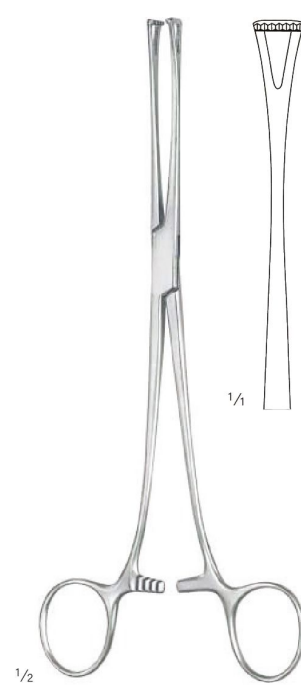

**Lockwood**  
**V17-111-20**  
20 cm / 7 7/8"



**Intestinal and Tissue Grasping Forceps**

Darm- und Gewebefassungen  
Pinzas para intestinos y tejidos  
Pincas pour saisir intestins et tissus  
Pinze per afferrare intestino e tessuti

TC GOLD

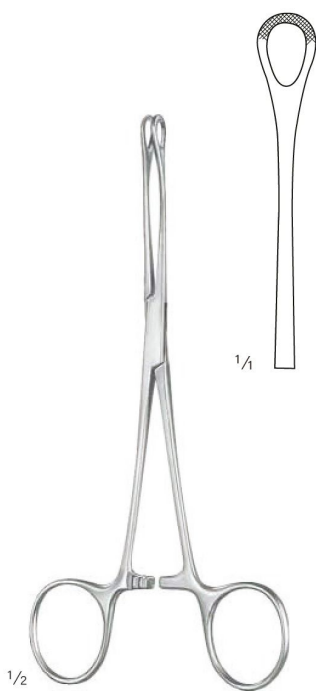

**Williams**  
V17-112-16  
16,5 cm / 6 4/8"



**Babcock**  
V17-113-16  
V17-113-20

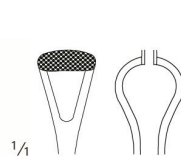

**V17-113-16**  
16,5 cm / 6 4/8"

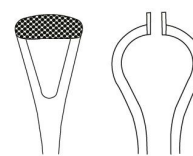

**V17-113-20**  
21 cm / 8 2/8"



**Intestinal and Tissue Grasping Forceps**

Darm- und Gewebefasszangen  
 Pinzas para intestinos y tejidos  
 Pinces pour saisir intestins et tissus  
 Pinze per afferrare intestino e tessuti



**Babcock**  
**V17-114-15**  
**V17-114-24**

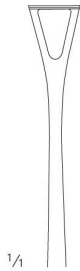

**V17-114-15**  
 15,5 cm / 6"

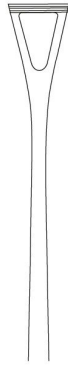

**V17-114-17**  
 17,5 cm / 7"

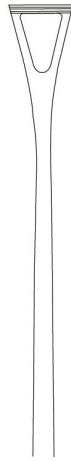

**V17-114-21**  
 21 cm / 8 3/8"

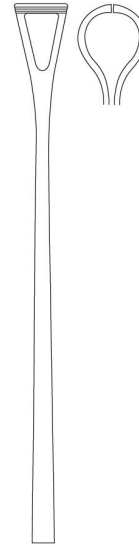

**V17-114-24**  
 24 cm / 9 1/8"

**Atrauma**

**TC HOLD**

**Atrauma**



**Babcock**  
**V17-115-16**  
 16 cm / 6 3/8"

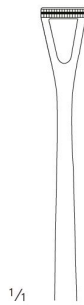

1/4

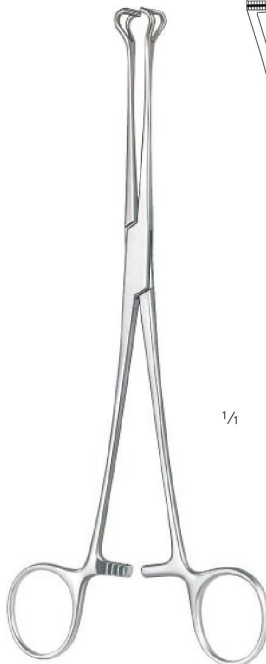

**Babcock**  
**V17-116-21**  
 21 cm / 8 3/8"

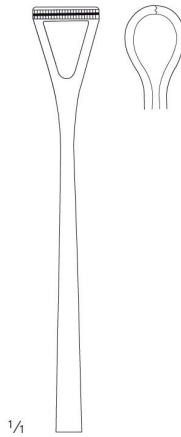

1/4



**Duval**  
**V17-117-20**  
 20,5 cm / 8"

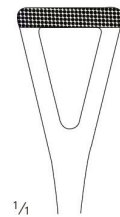

1/4



**Intestinal and Tissue Grasping Forceps, Intestinal Clamps**

Darm- und Gewebefasszangen, Darmklemmen  
Pinzas para intestinos y tejidos, Pinzas intestinales  
Pinces pour saisir intestins et tissus, Pincés intestinales  
Pinze per afferrare intestino e tessuti, Pinze intestinali

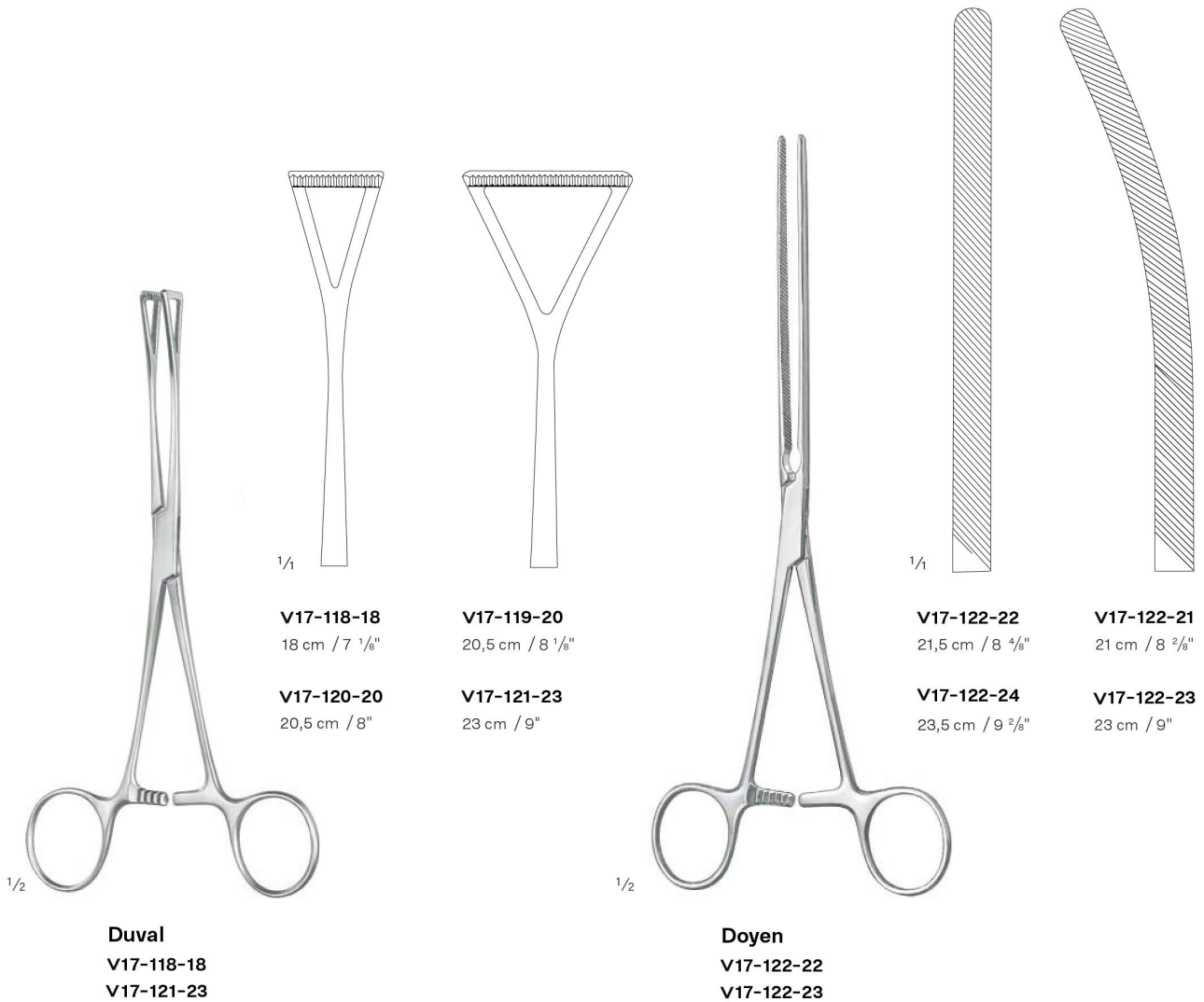

**Intestinal Clamps**

Darmklemmen  
Pinzas intestinales  
Pincas intestinales  
Pinze intestinali



1/2

**Doyen-Baby**  
**V17-123-18**  
**V17-123-17**

1/4



**V17-123-18**  
18 cm / 7 1/8"

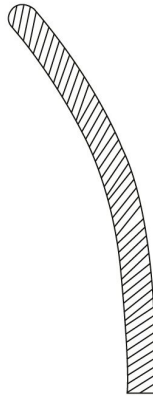

**V17-123-17**  
17,5 cm / 6 7/8"





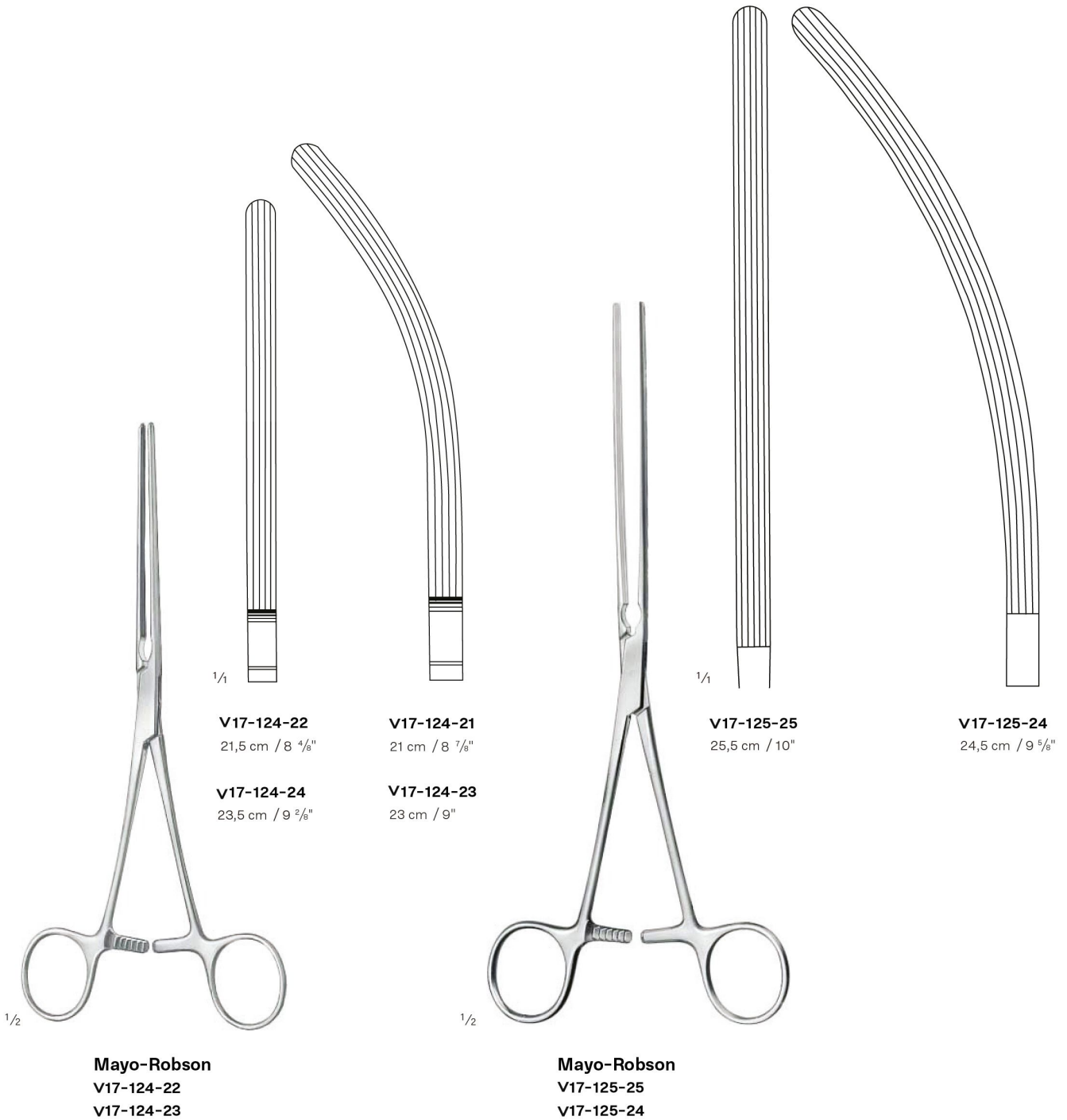

**Intestinal Clamps**  
Darmklemmen  
Pinzas intestinales  
Pinces intestinales  
Pinze intestinali



1/2

**Kocher**  
**V17-126-22**  
**V17-126-28**

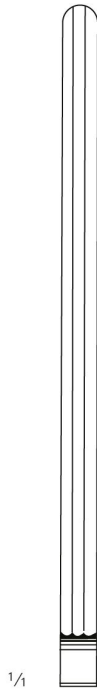

1/4

**V17-126-22**  
22,5 cm / 8 7/8"

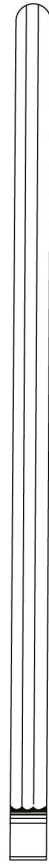

**V17-126-25**  
25 cm / 9 7/8"

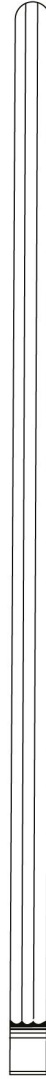

**V17-126-28**  
28 cm / 11"





1/2

**Kocher**  
 V17-127-22  
 V17-127-27

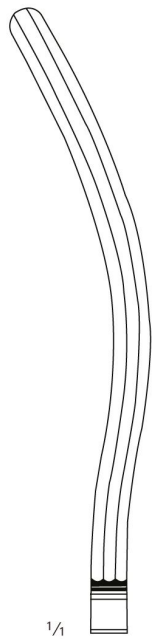

1/1

**V17-127-22**  
 22 cm / 8 5/8"

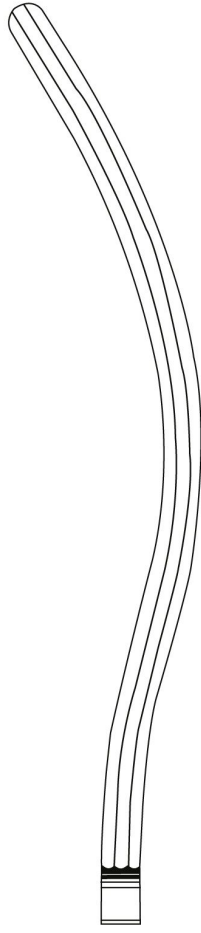

**V17-127-24**  
 24,5 cm / 9 5/8"

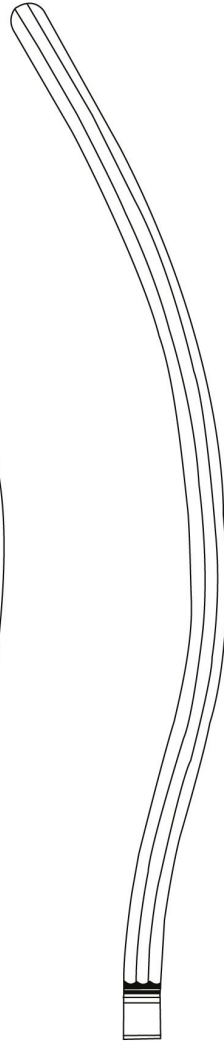

**V17-127-27**  
 27,5 cm / 10 5/8"

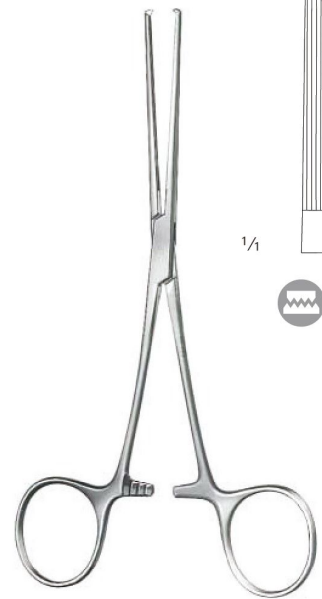

1/2

**Allen**  
 V17-128-16  
 16 cm / 6 2/8"

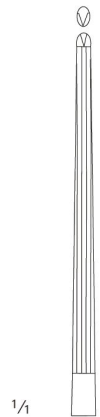

1/1



1:2

**Intestinal and Pylorus Clamps**

Darmquetschklemmen  
Pinzas intestinales para piloro  
Ecraseurs pour intestin  
Schiacciatori intestinali



**Payr-Baby**  
**V17-129-15**

15 cm / 5 7/8"

mit Stift  
with pin  
con espiga  
avec cheville  
con perno



**Payr**

**V17-130-21**  
**V17-130-34**

mit Stift  
with pin  
con espiga  
avec cheville  
con perno

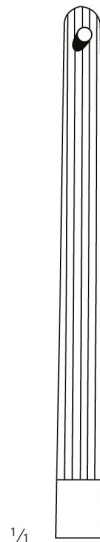

**V17-130-21**  
21 cm / 8 2/8"

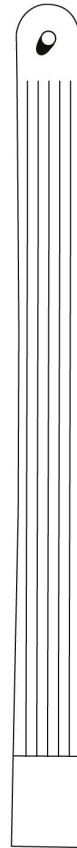

**V17-130-29**  
29 cm / 11 3/8"

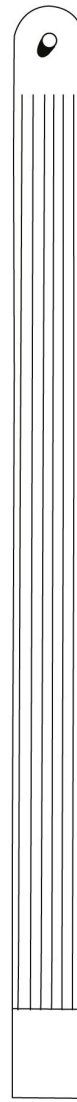

**V17-130-34**  
34 cm / 13 3/8"



## Intestinal Anastomosis Clamps

Darm-Anastomosenklemmen  
Clamps para anastomosis intestinales  
Pinces pour anastomoses intestinale  
Pinze per anastomosi intestinali



**V17-131-05**  
Arbeitslänge  
working length  
largo útil  
longueur utile  
lunghezza utile  
65 mm

**V17-131-07**  
Arbeitslänge  
working length  
largo útil  
longueur utile  
lunghezza utile  
80 mm

**V17-131-10**  
Arbeitslänge  
working length  
largo útil  
longueur utile  
lunghezza utile  
110 mm

### De Martel-Wolfson

#### V17-131-05

#### V17-131-10

Set bestehend aus 3 Stück einer Länge:

- 2 x Riegel kurz
- 1 x Riegel lang

Set consisting of 3 pieces of one length:

- 2 x lock, short
- 1 x lock, long

Juego formado por 3 piezas de una longitud:

- 2 x pestillo corto
- 1 x pestillo largo

Set composé de 3 pièces d'une longueur:

- 2 x verrou, court
- 1 x verrou, long

Set composto da 3 pezzi di una lunghezza:

- 2 x serrature corte
- 1 x serratura lunga

### De Martel-Wolfson

#### V17-132-27

27 cm / 10 5/8"

Klemmschließzange

Closing Forceps

Pinza para cerrar grapas

Pinces pour fermer les clips

Serrapinze



V17-131-05  
V17-131-10



## Intestinal Anastomosis Clamps

Darm-Anastomosenklemmen  
Clamps para anastomosis intestinales  
Pincas pour anastomoses intestinale  
Pinze per anastomosi intestinali



### De Martel-Wolfson

**V17-133-09**

9,5 cm / 3 7/8"

Klemmenhalterung  
Clamp Holder  
Porta-clamp  
Porte-clamps  
Portapinze



V17-131-05  
V17-131-10



### De Martel-Wolfson

**V17-134-23**

23 cm / 9"

Klemmenhalterung  
Clamp Holder  
Porta-clamp  
Porte-clamps  
Portapinze



V17-131-05  
V17-131-10



### Benson

**V17-135-15**

15,5 cm / 6 1/8"

Pylorusspreizer  
Pylorus Spreader  
Separador para piloro  
Ecarteur pour pylore  
Divaricatore piloro



## Intestinal Anastomosis Clamps

Darm-Anastomosenklemmen  
Clamps para anastomosis intestinales  
Pincés pour anastomoses intestinale  
Pinze per anastomosi intestinali



**V17-136-07**  
8,5 cm / 3 <sup>3</sup>/<sub>8</sub>"

**V17-136-10**  
11 cm / 4 <sup>3</sup>/<sub>8</sub>"

**Stone-Watt**  
**V17-136-07**  
**V17-136-10**



**Stone-Watt**  
**V17-137-00**

Klemmschloß  
Locking Device  
Cierre para clamps intestinales  
Serrure pour clamps intestinales  
Serratura per pinze intestinali



**Stone-Watt**  
**V17-138-16**  
16 cm / 6 <sup>2</sup>/<sub>8</sub>"

Schließklemme  
Closing Forceps  
Pinza para cerrar clamps  
Pinze pour fermer et porter les champs  
Serrapinze e portapinze



**Stomach and Intestinal Anastomosis Twin Clamps**

Magen- und Darm-Zwillingsklemmen  
Pinzas gastro-intestinales gemelas  
Pincas stomacales et intestinales jumelées  
Pinze gastrointestinali gemelle



1/2

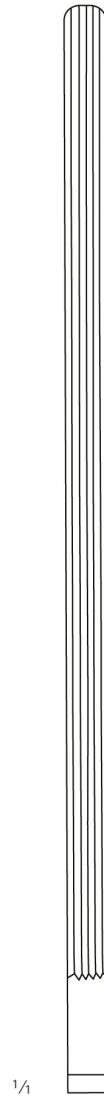

1/4



**Lane**  
**V17-139-30**  
30 cm / 11 5/8"



**Stomach and Intestinal Anastomosis Twin Clamps**

Magen- und Darm-Zwillingsklemmen  
Pinzas gastro-intestinales gemelas  
Pincas stomacales et intestinales jumelées  
Pinze gastrointestinali gemelle



**Lane**  
**V17-140-30**  
30 cm / 11  $\frac{5}{8}$ "

## Organ Grasping Forceps

Organfasszangen  
Pinzas para coger órganos  
Pinces pour saisir des organes  
Pinze per afferrare organi

### Atrauma



1/1

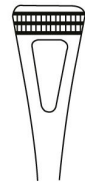

#### V17-141-18

18 cm / 7 1/8"

schmal  
narrow  
estrecho  
étroit  
stretto

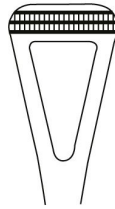

#### V17-141-20

20,5 cm / 8 1/8"

mittel  
medium  
mediano  
moyen  
medio

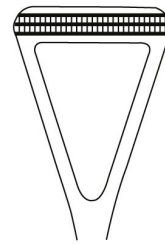

#### V17-141-23

23 cm / 9"

breit  
wide  
ancho  
large  
largo



#### Scheibe

V17-141-18

V17-141-23

**Atrauma**



1/2

**Doyen-Baby**  
**V17-142-14**  
**V17-142-23**

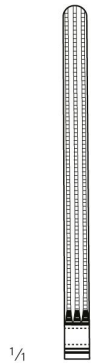

1/1

**V17-142-14**  
 14 cm / 5 4/8"



**V17-142-17**  
 17 cm / 6 5/8"

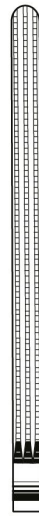

**V17-142-18**  
 18,5 cm / 7 3/8"

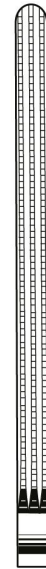

**V17-142-21**  
 21,5 cm / 8 4/8"

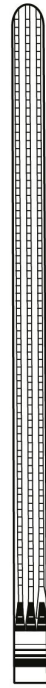

**V17-142-23**  
 23,5 cm / 9 2/8"



1/2

**Doyen-Baby**  
**V17-143-13**  
**V17-143-23**

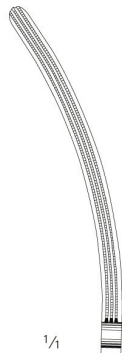

1/1

**V17-143-13**  
 13,5 cm / 5 2/8"

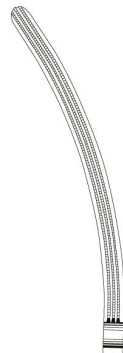

**V17-143-16**  
 17 cm / 6 5/8"

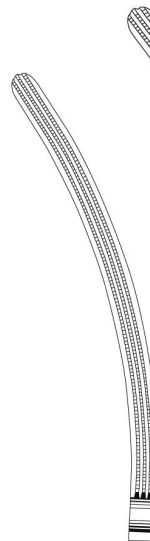

**V17-143-18**  
 18 cm / 7"



**V17-143-13**

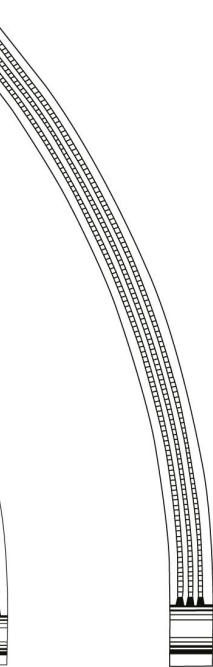

**V17-143-16**



**V17-143-18**

**Intestinal Clamps**  
 Darmklemmen  
 Pinzas intestinales  
 Pinces intestinales  
 Pinze intestinali

**Atrauma**



**Mayo-Robson**  
**V17-144-26**  
 26 cm / 10 <sup>2</sup>/<sub>8</sub>"



**Mayo-Robson**  
**V17-145-25**  
 25 cm / 9 <sup>2</sup>/<sub>8</sub>"



**Intestinal Clamps**  
Darmklemmen  
Pinzas intestinales  
Pincas intestinales  
Pinze intestinali

**Atrauma**



1/2

**Kocher**  
V17-146-22  
V17-146-28

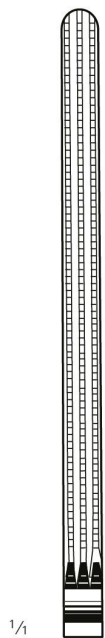

1/1

**V17-146-22**  
22,5 cm / 8 7/8"



**V17-146-25**  
25 cm / 9 7/8"

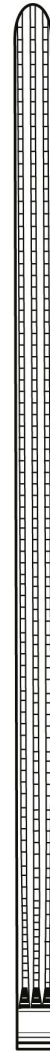

**V17-146-28**  
28 cm / 11"



**Intestinal Clamps**  
Darmklemmen  
Pinzas intestinales  
Pincas intestinales  
Pinze intestinali

**Atrauma**



1/2

**Kocher**  
**V17-147-22**  
**V17-147-27**

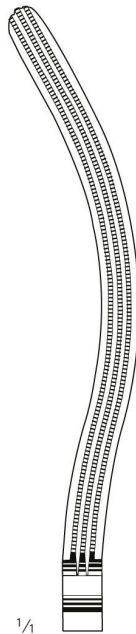
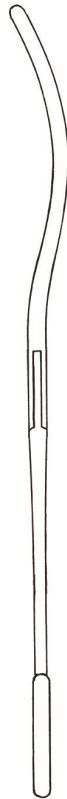

1/4

**V17-147-22**  
22 cm / 8 5/8"

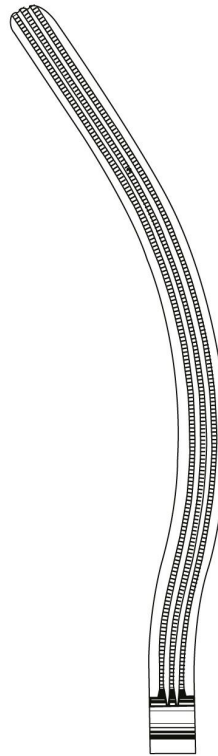

**V17-147-24**  
24,5 cm / 9 5/8"

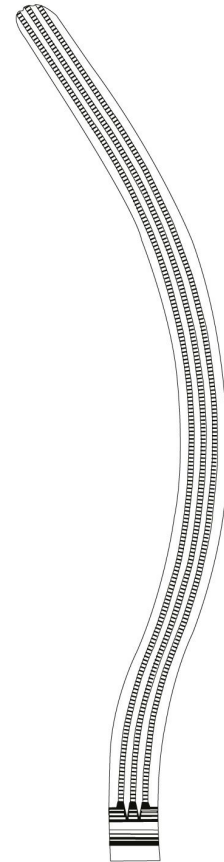

**V17-147-27**  
27 cm / 10 5/8"



**Intestinal Clamps**  
 Darmklemmen  
 Pinzas intestinales  
 Pinces intestinales  
 Pinze intestinali

**Atrauma**



**V17-148-33**  
 33,5 cm / 13 2/8"

**Scudder**  
**V17-148-33**  
**V17-149-33**

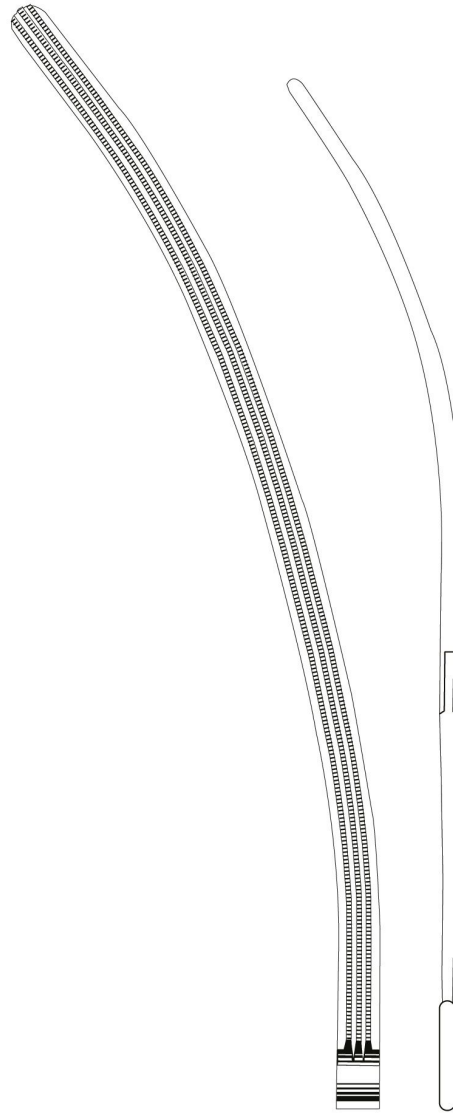

**V17-149-33**  
 32,5 cm / 12 5/8"

**Brunner**  
**V17-150-27**  
 27 cm / 10 5/8"



**Sigmoid Anastomosis Forceps**  
Rektum-Anastomosenklemmen  
Pinzas para anastomosis rectales  
Pinces pour anastomoses rectales  
Pinze per anastomosi retтали

**Atrauma**



1/2

**Hayes**  
V17-151-27  
V17-151-28

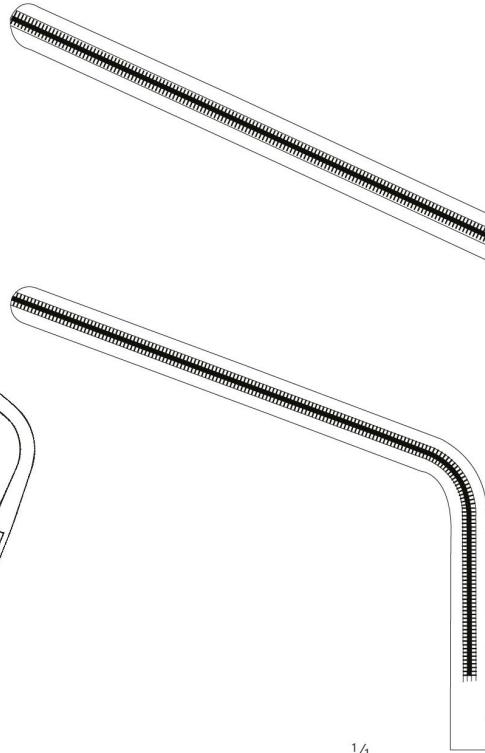
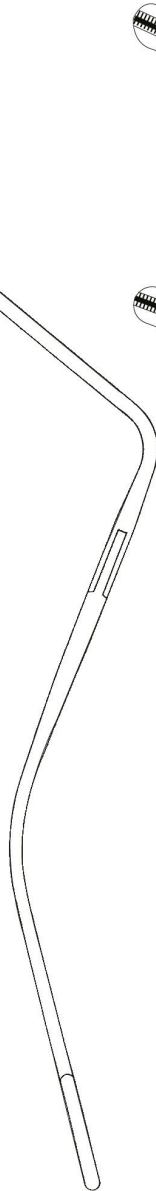

1/1

**V17-151-27**  
27 cm / 10 5/8"

**V17-151-28**  
28 cm / 11"





**Sigmoid Anastomosis Forceps**  
Rektum-Anastomosenklemmen  
Pinzas para anastomosis rectales  
Pincès pour anastomoses rectales  
Pinze per anastomosi rettili

**Atrauma**



**Veidenheimer**  
V17-152-25  
25 cm / 9 7/8"

**Fehland**  
V17-153-24  
24 cm / 9 4/8"

**Sigmoid Anastomosis Forceps**  
Rektum-Anastomosenklemmen  
Pinzas para anastomosis rectales  
Pinces pour anastomoses rectales  
Pinze per anastomosi retтали

**Atrauma**



1/2

1/4

**Resano**  
**V17-154-28**  
28 cm / 11"



**Rectal Specula, Rectal Spreaders**

Mastdarmspekula, Analspreizer  
Especulos rectales, Separadores rectales  
Spéculums rectaux, Ecarteurs rectaux  
Specoli rettali, Divaricatori rettali



105 x 23 mm

1/2

**Czerny**  
**V17-155-22**  
22,5 cm / 8 7/8"



70 x 15 mm

1/2

**Sims**  
**V17-156-15**  
15,5 cm / 6 1/8"



70 x 15 mm

1/2

**Sims**  
**V17-157-15**  
15,5 cm / 6 1/8"



80 x 25 mm

1/2

**Pratt**  
**V17-158-20**  
20 cm / 7 7/8"



Ø 22 mm

1/2

**Ives-Fansler**  
**V17-159-15**  
Analspreizer  
Rectal Spreaders  
Separadores rectales  
Ecarteurs rectaux  
Divaricatori rettali

Arbeitslänge  
working length  
largo útil  
longueur utile  
lunghezza utile  
80 mm

**Rectal Spreaders**  
 Analspreizer  
 Separadores rectales  
 Ecarteurs rectaux  
 Divaricatori rettali



1/2

**Alan-Parks**  
**V17-160-00**  
**V17-160-95-98**

**V17-160-00**  
 14 cm / 5 4/8"  
 ohne Kaltlichtaufsatz  
 without F.O. light carrier  
 sin portador de luz fría  
 sans support lumière froide  
 senza supporto per luce fredda



**V17-160-94-98**  
 Paar Seitenvalven lang, Nutzlänge 95 mm  
 Pair of lateral blades, long, useful length 95 mm  
 Un par de valvas laterales, largas, longitud útil 95 mm  
 Paire de valves latérales, longues, longueur utile 95 mm  
 Coppia di valve laterali lunghe, lungh. utile 95 mm

**V17-160-95-98**  
 Mittelvalve, Nutzlänge 95 mm  
 Central Blade, useful length 95 mm  
 Valva central, longitud útil 95 mm  
 Valve centrale, longueur utile 95 mm  
 Valva centrale, lungh. utile 95 mm

**V17-160-92-98**  
 Flügelmutter  
 Wing nut  
 Tuerca de mariposal  
 Ecrou à oreilles  
 Madrevite ad alette

**V17-160-93-98**  
 Paar Seitenvalven kurz, Nutzlänge 75 mm  
 Pair of lateral blades, short, useful length 75 mm  
 Un par de valvas laterales, cortas, longitud útil 75 mm  
 Paire de valves latérales, courtes, longueur utile 75 mm  
 Coppia di valve laterali corte, lungh. utile 75 mm



**Sphincteroscopes, Hemorrhoidal Ligator**  
 Sphinkteroskope, Hämorrhoidal-Ligator  
 Esfincteroscopios, Ligador para hemorroides  
 Sphinctérosopes, Ligateur pour h morroides  
 Sfincteroscopi, Legatore emorroidale



1/2

**V17-161-21**

Ø 21 mm  
 Arbeitslänge  
 working length  
 largo útil  
 longueur utile  
 lunghezza utile  
 50 mm

**V17-161-27**

Ø 27 mm  
 Arbeitslänge  
 working length  
 largo útil  
 longueur utile  
 lunghezza utile  
 50 mm

**Kelly**  
**V17-161-21**  
**V17-161-27**



1/2

**V17-162-26**

Ladekonus  
 Loading Cone  
 Cono de carga  
 Cône de charge  
 Cono per caricare



**Rudd**

**V17-163-04**  
**V17-163-27**



**V17-163-04**

Ligatur-Gummiringe  
 Rubber Rings  
 Anillos de goma  
 Anneaux en caoutchouc  
 Anelli di gomma

Packung mit 100 Stück  
 package of 100 pieces  
 paquete con 100 piezas  
 paquet avec 100 pièces  
 confezione di 100 pezzi



B17-163-27

**V17-163-27**

27,5 cm / 10 7/8"  
 komplett mit Ladekonus  
 complete with loading cone  
 completo con cono de carga  
 complet avec cône de charge  
 completo con cono per caricare



**Hemorrhoidal Ligator, Rectal Biopsy Forceps**

Hämorrhoidal-Faßzange, Rektum-Biopsiefasszangen  
Ligador para hemorroides, Pinzas para biopsia rectal  
Ligateur pour hémorroïdes, Pinces pour biopsie rectale  
Legatore emorroidale, Pinze per biopsia rettale

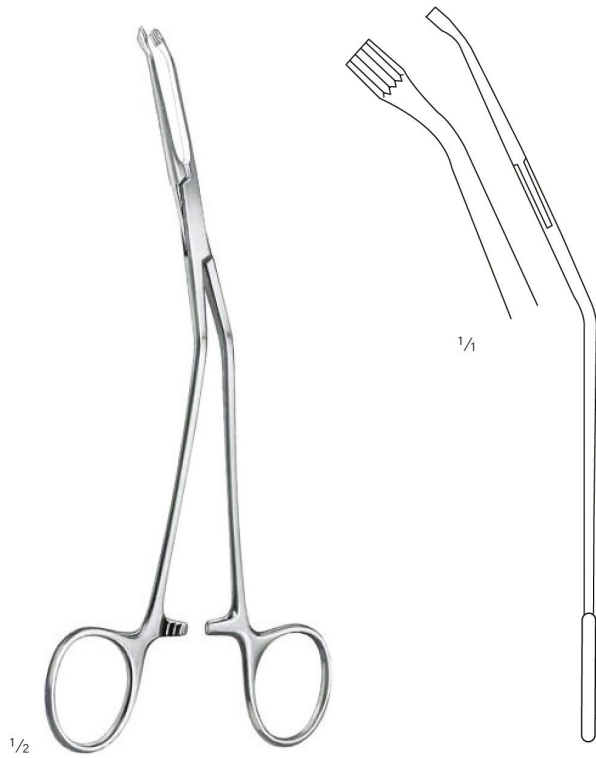

**McGinvey**  
**V17-164-19**  
19,5 cm / 7 5/8"

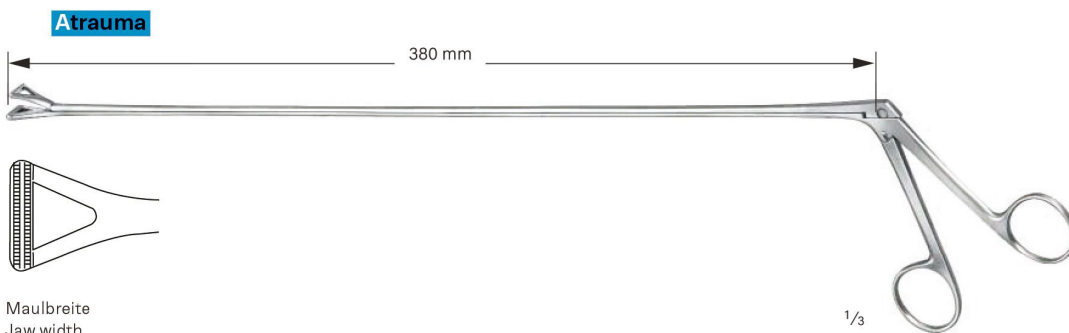

**Atrauma**  
380 mm  
**Maulbreite**  
Jaw width  
Anchura de la boca  
Lageur de mors  
Larghezza della bocca  
15 mm

**V17-165-38**  
38 cm / 15"



**no one does it BETTER**



**Cell:** +92 334 6113800

**URL:** <https://vorlinginstruments.com>

**Email:** [info@vorlinginstruments.com](mailto:info@vorlinginstruments.com)

**Address:**

Kacha Shahab Pura Road

Jeewan Pura, Sialkot (51310)

Pakistan.

