

INCREDIBLY REUSABLE

• FLEXIBLE
USE SURGERY
ASSISTANT

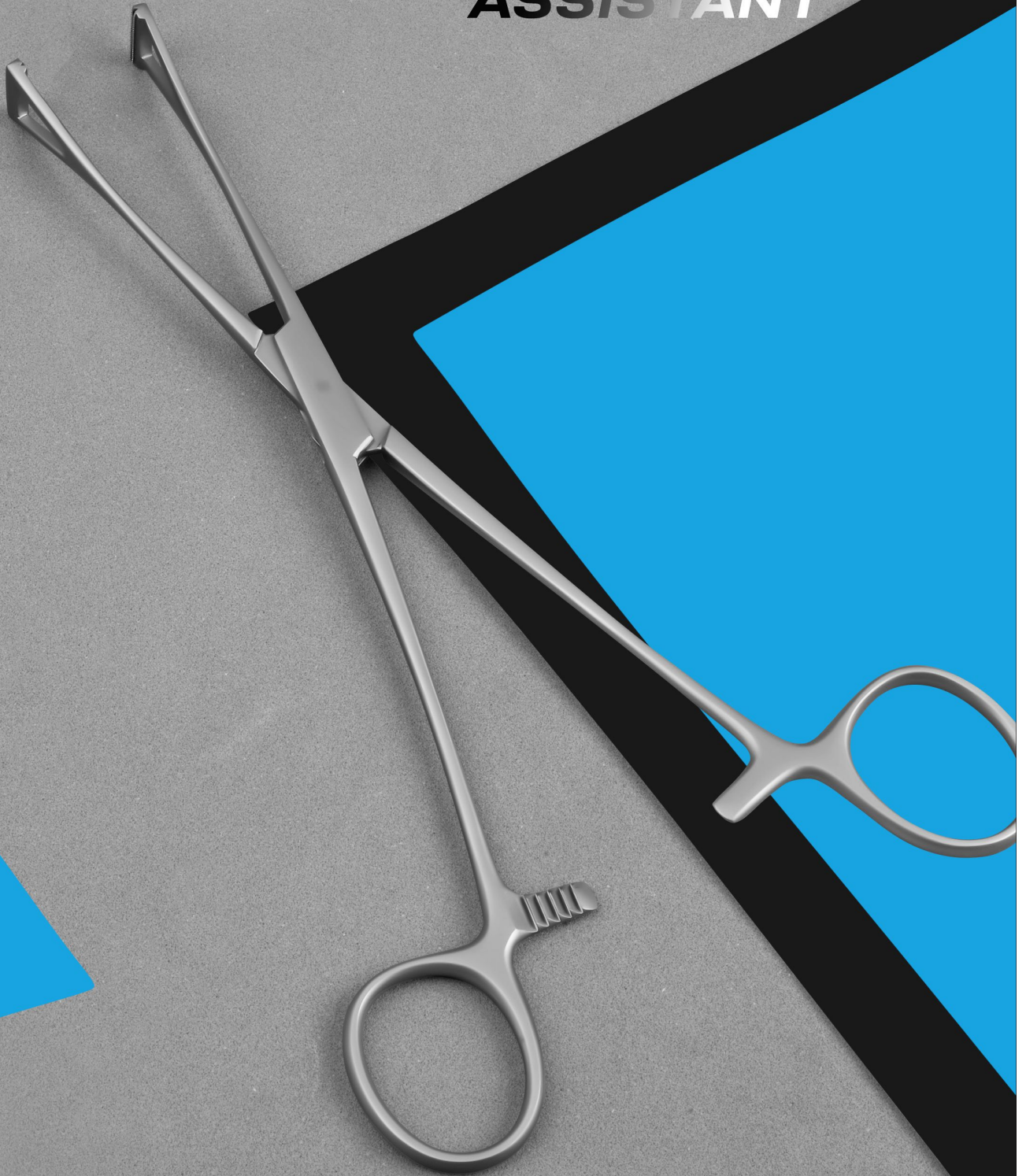

ARTERY +
FORCEPS



VORLING
instruments

HAS THE REPUTATION OF BEING THE ONLY IN PAKISTAN THAT MANUFACTURES ITS OWN TOOLS FOR THE PRODUCTION OF ITS INSTRUMENTS.

An Era Of **evolution**

VORLING instruments is a privately owned company providing personalized services and the finest in Surgical Instruments for over 25 years. Established in 1999, Our Company manufactures a wide range of Surgical, Dental and Veterinary Instruments.

All Instruments and devices of our product range are manufactured by well-trained and experienced skilled workers with special craftsmanship and by use of most modern machines and equipment. On this occasion we only use materials which meet our high standards. The CEO of Vorling Instruments, Mr. Muhammad Ahmed brings with him a lifetime of knowledge about the world of surgical instruments.

This insight allows us to understand the needs of our customers in a way most other instrument companies are unable to do.

After becoming a competent oem service provider, cardiac has decided to introduce itself as the original source of high quality instrumentation to directly interact with some of the well-known brands around the world.

Clip Applying Forceps, Vessel Clips

Clip-Anlegepinzette, Gefäßclips
 Pinzas para aplicar clips,
 Pincas pour poser les clips vasculaires, Clips vasculaires
 Pinze per applicazione clips vascolari,



Biemer
V04-100-16
 16 cm / 6 5/8"
 Gefäßspreizer
 Vascular spreader
 Dilatador de vasos
 Ecarteur vasculaire
 Dilatatore vascolare



V04-101-14
 14,5 cm / 5 7/8"
 ohne Sperre
 w/o ratchet
 sin cremallera
 sans cremaillère
 senza cremagliera



V04-102-14
 14,5 cm / 5 7/8"
 mit Sperre
 with ratchet
 con cremallera
 avec cremaillère
 con cremagliera

➔ **V04-103-04**
V04-110-04

➔ **V04-103-04**
V04-110-04



Biemer
V04-103-04
V04-104-05



St	V04-103-04	V04-103-05	V04-104-05
	14 mm	17 mm	17 mm
	6 mm	9 mm	9 mm
	4 mm	7 mm	7 mm
	30 - 40 g	30 - 40 g	20 - 25 g



Vessel Clips, Approximators
 Gefäßclips, Approximatoren
 Clips vasculares, Aproximadores
 Clips vasculaires, Approximateurs
 Clip vascolari, Approssimatori



Biemer-Müller
V04-105-05
V04-109-05



	gerade, breit straight, wide recto, ancho droit, large retto, largo	gewinkelt, breit angled, wide angulado, ancho coudé, large angulato, largo	gerade, schmal straight, narrow recto, estrecho droit, étroit retto, stretto	gerade, schmal straight, narrow recto, estrecho droit, étroit retto, stretto	gewinkelt, schmal angled, narrow angulado, estrecho coudé, étroit angulato, stretto
St	V 04-105-05	V04-106-05	V04-107-03	V04-108-05	V04-109-05
	17 mm	17 mm	13 mm	17 mm	17 mm
	9 mm	9 mm	6 mm	9 mm	9 mm
	7 mm	7 mm	4 mm	7 mm	7 mm
P	30 - 40 g	30 - 40 g	30 - 40 g	30 - 40 g	25 - 30 g



Müller
V04-110-01
V04-110-04



Ø	1,5 mm	2,5 mm	3,0 mm	3,5 mm
St	V 04-110-01	V04-110-02	V04-110-03	V 04-110-04
	17 mm	17 mm	17 mm	17 mm
	9 mm	9 mm	9 mm	9 mm
	7 mm	7 mm	7 mm	7 mm
P	30 - 40 g	30 - 40 g	30 - 40 g	30 - 40 g



Approximators, Nerve Approximators
 Approximatoren, Nerv-Approximatoren
 Aproximadores, Aproximadores para nervios
 Approximateurs, Approximateurs pour nerfs
 Approssimatori, Approssimatori per nervi

für Mikro-Gefäßanastomosen in der Tiefe
 for Micro vessel anastomosis in the depth
 para micro anastomosis en la profundidad
 pour micro-anastomoses vasculaires en profondeur
 per micro-anastomosi vascolari nella profondità

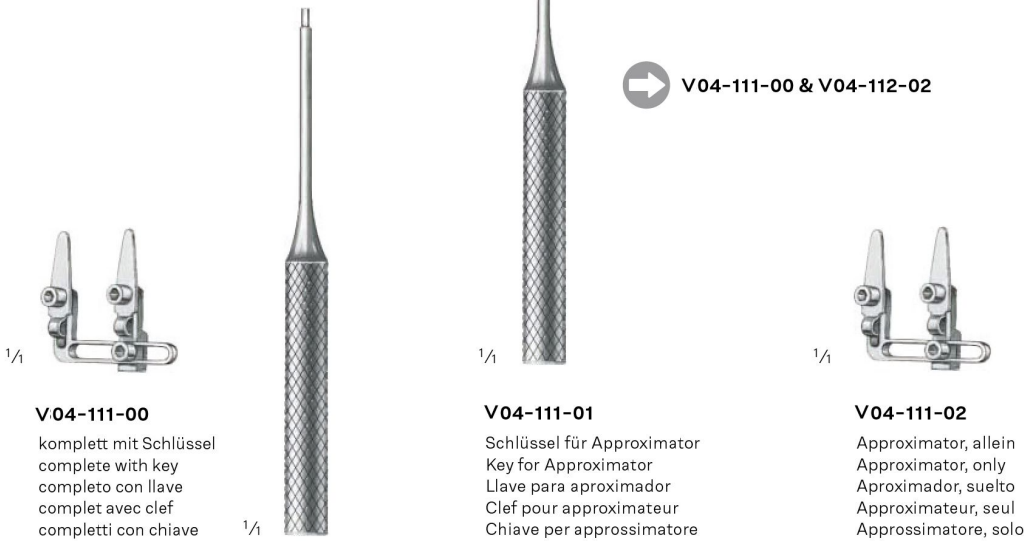

V04-111-00
 komplett mit Schlüssel
 complete with key
 completo con llave
 complet avec clef
 completti con chiave

V04-111-01
 Schlüssel für Approximator
 Key for Approximator
 Llave para aproximador
 Clef pour approximateur
 Chiave per approssimatore

V04-111-02
 Approximator, allein
 Approximator, only
 Aproximador, suelto
 Approximateur, seul
 Approssimatore, solo

Nadeln mit Schlüssel auswechselbar
 needles exchangeable by means of key
 agujas cambiables con llave
 aiguilles échangeable avec la clé
 aghi intercambiabili con una chiave



V04-112-00
 komplett mit Schlüssel
 complete with key
 completo con llave
 complet avec clef
 completti con chiave

V04-112-02
 Approximator mit Nadeln, allein
 Approximator with needles, only
 Aproximador con agujas, suelto
 Approximateur avec aiguille, seul
 Approssimatore con aghi, solo

V04-112-04
 Ersatznadeln, allein
 Spare Needles, only
 Agujas de repuesto, suelto
 Aiguilles de rechange, seul
 Aghi di ricambio, solo
 Paar
 pair
 par
 paire
 paio

V04-112-02

Mini Vessel Clips, Clip Applying Forceps

Mini-Gefäßclips, Clip-Anlegezangen, Bulldogklemmen
 Mini Clips vasculares, Pinzas para aplicar clips
 Micro-clips vasculaires, Pincettes pour poser micro-clips
 Mini-clip vascolari, Pinze per applicare clips vascolari



1/2

➔ V04-115-04
 V04-115-10

V04-113-14

14,5 cm / 5 5/8"
 mit Sperre
 with ratchet
 con cremallera
 avec cremaillère
 con cremagliera



1/2

➔ V04-115-04
 V04-115-10

V04-114-18

18,5 cm / 7 2/8"
 mit Sperre
 with ratchet
 con cremallera
 avec cremaillère
 con cremagliera



1/4

V04-115-04
V04-115-10

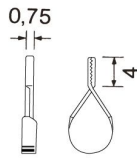

1/4

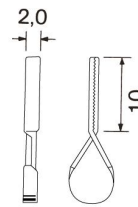
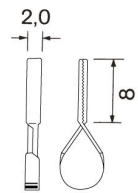
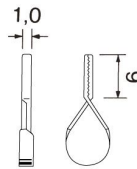

St	V 04-115-04	V 04-115-06	V04-115-08	V04-115-10
	13 mm	15 mm	17 mm	20 mm
	4 mm	6 mm	8 mm	10 mm
	4 mm	5 mm	6 mm	7 mm
P	60 g	85 g	100 g	125 g





V04-116-10
V04-117-18

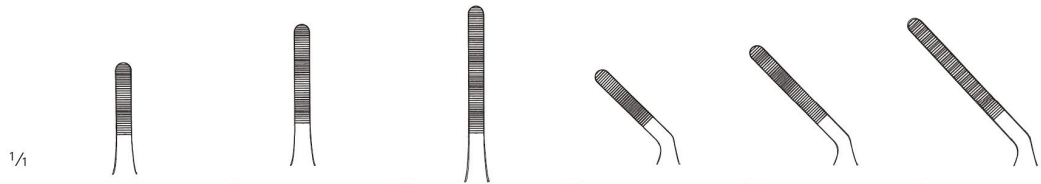

St	V 04-116-10	V04-116-14	V04-116-18	V04-117-10	V04-117-14	V 04-117-18
	31 mm	35 mm	39 mm	30 mm	33 mm	36 mm
	10 mm	14 mm	18 mm	10 mm	14 mm	18 mm
	30 g	30 g	30 g	30 g	30 g	30 g



Dieffenbach
V04-118-06
V04-123-05

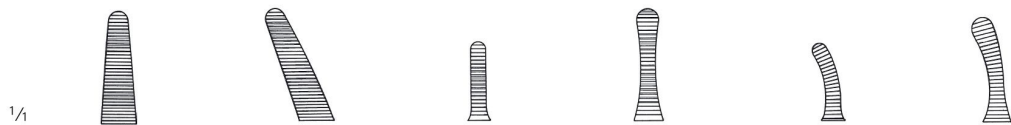

St	V 04-118-06	V04-119-06	V04-120-03	V04-121-05	V04-122-03	V 04-123-05
	6 cm / 2 3/8"	6 cm / 2 3/8"	3,5 cm / 1 3/8"	5 cm / 2"	3,5 cm / 1 3/8"	5 cm / 2"
	17 mm	17 mm	11 mm	15 mm	11 mm	15 mm

Bulldog Clamps
 Bulldogklemmen
 Clamps Bulldog
 Clamps Bulldog
 Pinze Bulldog



1/2

Johns-Hopkins
V04-124-38
V04-124-90

1/4

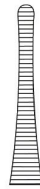
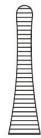

St	V04-124-38	V04-124-45	V04-124-55	V04-124-65	V04-124-70	V04-124-75	V04-124-90
	3,8 cm / 1 3/8"	4,5 cm / 1 5/8"	5,5 cm / 2 1/8"	6,5 cm / 2 4/8"	7 cm / 2 4/8"	7,5 cm / 3"	9 cm / 3 4/8"
	12 mm	17 mm	25 mm	30 mm	35 mm	40 mm	50 mm
P	300 g	300 g	300 g	300 g	300 g	300 g	300 g



1/2

Johns-Hopkins
V04-125-38
V04-125-90

1/4

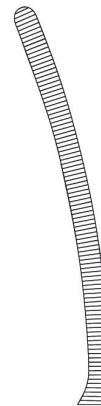

St	V04-125-38	V04-125-45	V04-125-55	V04-125-65	V04-125-70	V04-125-75	V04-125-90
	3,8 cm / 1 3/8"	4,5 cm / 1 5/8"	5,5 cm / 2 1/8"	6,5 cm / 2 4/8"	7 cm / 2 4/8"	7,5 cm / 3"	9 cm / 3 4/8"
	12 mm	17 mm	25 mm	30 mm	35 mm	40 mm	50 mm
P	300 g	300 g	300 g	300 g	300 g	300 g	300 g



Bulldog Clamps
 Bulldogklemmen
 Clamps Bulldog
 Clamps Bulldog
 Pinze Bulldog



1/2

Diethrich
 V04-126-08
 V04-127-12

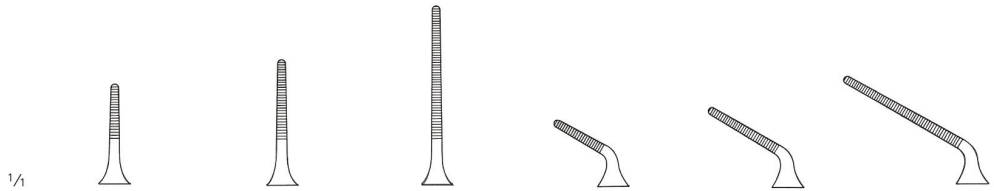

1/4

St	V 04-126-08	V 04-126-10	V 04-126-12	V 04-127-08	V 04-127-10	V 04-127-12
	45 mm	50 mm	60 mm	40 mm	45 mm	50 mm
	8 mm	12 mm	20 mm	8 mm	12 mm	20 mm
	50 g	50 g	50 g	50 g	50 g	50 g

Atrauma



1/2

DeBakey-Diethrich
 V04-128-10
 V04-134-20



1/4

St	V 04-128-10	V 04-128-14	V 04-128-20	V 04-130-10	V 04-130-14	V 04-130-20
	45 mm	50 mm	60 mm	35 mm	45 mm	50 mm
	10 mm	14 mm	20 mm	10 mm	14 mm	20 mm
	100 g	100 g	100 g	100 g	100 g	100 g

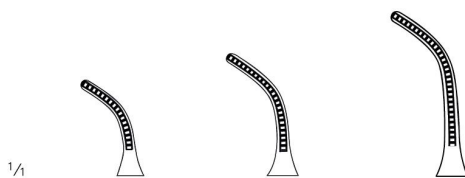

1/4

St	V 04-132-10	V 04-132-14	V 04-133-20
	35 mm	45 mm	50 mm
	10 mm	14 mm	20 mm
	100 g	100 g	100 g

Bulldog Clamps
 Bulldogklemmen
 Clamps Bulldog
 Clamps Bulldog
 Pinze Bulldog



1/4

Müller
V04-135-13
V04-144-12



St	V 04-135-13	V 04-136-13	V 04-137-17	V 04-138-13	V 04-139-12
	40 mm	40 mm	40 mm	40 mm	40 mm
	13 mm	13 mm	17 mm	13 mm	12 mm
	13 mm	13 mm	14 mm	13 mm	12 mm
	50 g	50 g	50 g	50 g	50 g

St	V 04-140-13	V 04-141-13	V 04-142-17	V 04-143-13	V 04-144-12
	40 mm	40 mm	40 mm	40 mm	40 mm
	13 mm	13 mm	17 mm	13 mm	12 mm
	13 mm	13 mm	14 mm	13 mm	12 mm
	80 g	80 g	80 g	80 g	80 g

* kniegebogen
 knee-bent
 acodado tipo rodilla
 genouillée
 a ginocchiera

Atrauma



1/2

V04-145-38
V04-146-50

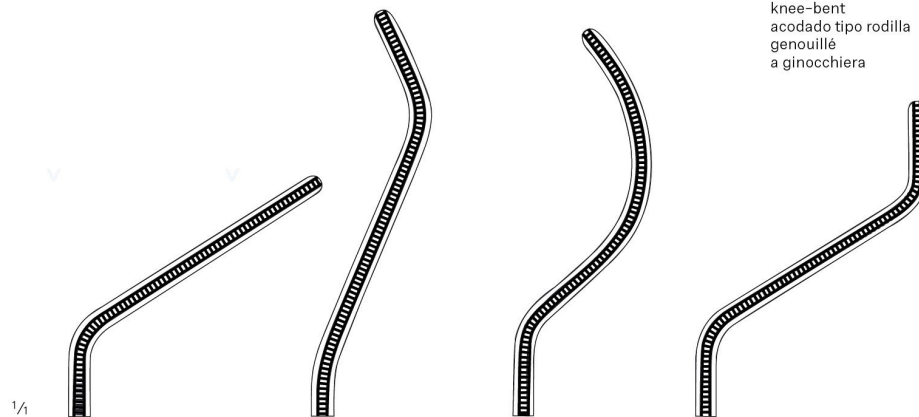

St	V 04-145-38	V 04-145-65	V 04-145-60	V 04-145 B50
	95 mm	120 mm	110 mm	105 mm
	38 mm	65 mm	60 mm	50 mm
	250 g	250 g	250 g	250 g

St	V 04-146-38	V 04-146-65	V 04-146-60	V 04-146-50
	95 mm	120 mm	110 mm	105 mm
	38 mm	65 mm	60 mm	50 mm
	350 g	350 g	350 g	350 g



Atrauma



1/1
Mini-Glover
V 04-147-30
V 04-148-50

1/1



Vena				
Ti	V 04-147-30	V 04-147-35	V 04-147-40	V 04-147-50
	30 mm	35 mm	40 mm	50 mm
	9 mm	13 mm	14 mm	23 mm
P	110 +/- 10 g	110 +/- 10 g	110 +/- 10 g	110 +/- 10 g

Arteria				
Ti	V 04-148-30	V 04-148-35	V 04-148-40	V 04-148-50
	30 mm	35 mm	40 mm	50 mm
	9 mm	13 mm	14 mm	23 mm
P	220 +/- 10 g	220 +/- 10 g	220 +/- 10 g	220 +/- 10 g

Atrauma



1/1
Mini-Glover
V 04-149-30
V 04-150-50

1/1

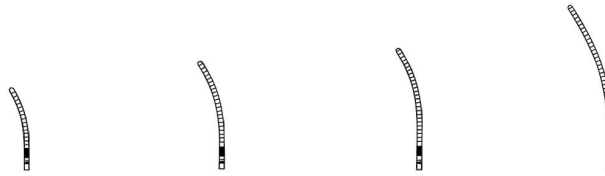

Vena				
Ti	V 04-149-30	V 04-149-35	V 04-149-40	V 04-149-50
	30 mm	35 mm	40 mm	50 mm
	9 mm	13 mm	14 mm	23 mm
P	110 +/- 10 g	110 +/- 10 g	110 +/- 10 g	110 +/- 10 g

Arteria				
Ti	V 04-150-30	V 04-150-35	V 04-150-40	V 04-150-50
	30 mm	35 mm	40 mm	50 mm
	9 mm	13 mm	14 mm	23 mm
P	220 +/- 10 g	220 +/- 10 g	220 +/- 10 g	220 +/- 10 g

Bulldog Clamps
 Bulldogklemmen
 Clamps Bulldog
 Clamps Bulldog
 Pinze Bulldog

Atrauma

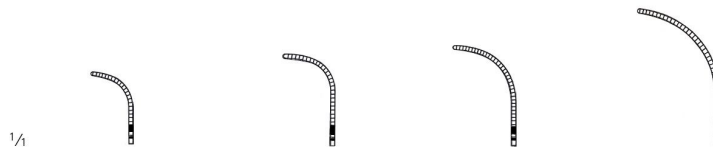

1/4

Mini-Glover
V04-152-30
V04-153-50

Vena				
Ti	V 04-152-30	V 04-152-35	V 04-152-40	V 04-152-50
	30 mm	35 mm	40 mm	50 mm
	9 mm	13 mm	14 mm	23 mm
	110 +/- 10 g	110 +/- 10 g	110 +/- 10 g	110 +/- 10 g

Arteria				
Ti	V 04-153-30	V 04-153-35	V 04-153-40	V 04-153-50
	30 mm	35 mm	40 mm	50 mm
	9 mm	13 mm	14 mm	23 mm
	220 +/- 10 g	220 +/- 10 g	220 +/- 10 g	220 +/- 10 g



1/2

Mini-Glover
V04-154-24

24 cm / 9 4/8"

Anlegezange für Bulldogklemmen, Mini-Glover
 Applying Forceps for Bulldog clamps, Mini-Glover
 Pinza applicadora para clamps bulldog, Mini-Glover
 Pince pour poser les clamps Bulldog, Mini-Glover
 Pinza per posizionare le pinze Bulldog, Mini-Glover

V04-152-30
V04-153-50



Haemostatic Forceps
 Arterienklemmen
 Pinzas hemostáticas
 Pincas hémostatiques
 Pinze emostatiche



1/2

Pean
V 04-155-14
V 04-155-16

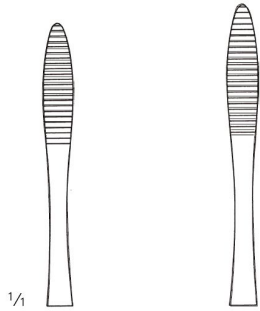

1/4

V04-155-14
 14,5 cm / 5 9/16"

V04-155-16
 16 cm / 6 2/8"



1/2

Spencer-Wells
V 04-156-13
V 04-157-20

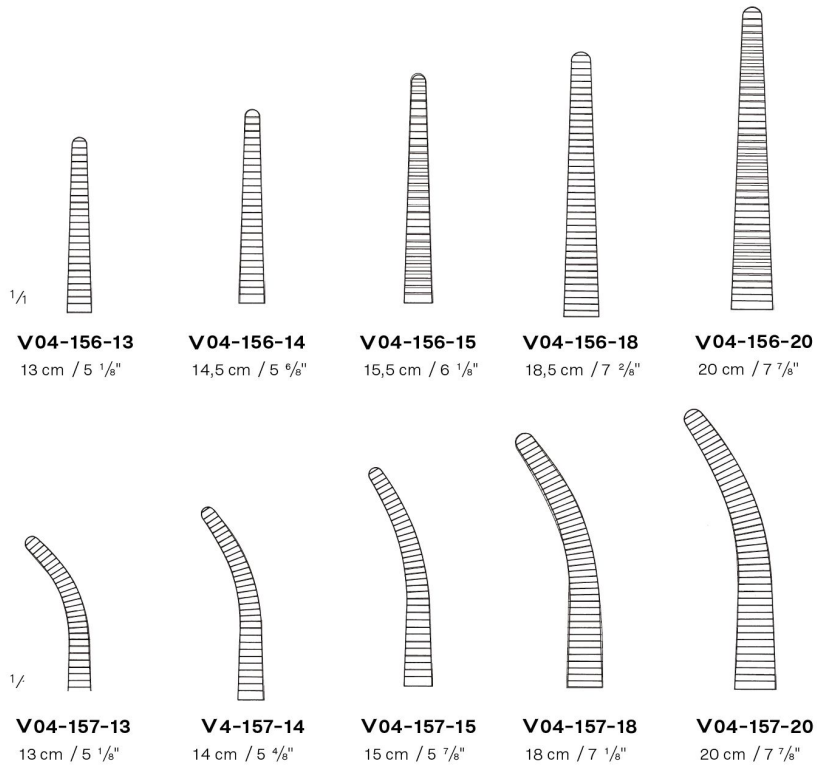

1/4

V04-156-13
 13 cm / 5 1/8"

V04-156-14
 14,5 cm / 5 9/16"

V04-156-15
 15,5 cm / 6 1/8"

V04-156-18
 18,5 cm / 7 3/8"

V04-156-20
 20 cm / 7 7/8"

1/4

V04-157-13
 13 cm / 5 1/8"

V 4-157-14
 14 cm / 5 5/16"

V04-157-15
 15 cm / 5 7/8"

V04-157-18
 18 cm / 7 1/8"

V04-157-20
 20 cm / 7 7/8"

Haemostatic Forceps, Organ Grasping Forceps
 Arterienklemmen, Organfasszangen
 Pinzas hemostáticas, Pinzas para sacar órganos
 Pincès hémostatiques, Pincès pour saisir organes
 Pinze emostatiche, Pinze per afferrare organi



Chaput
V04-158-12
 12,5 cm / 4 7/8"



Tuffier
V04-159-12
 12,5 cm / 4 7/8"

Atrauma



V04-160-25
V04-160-26



V04-160-25
 25 cm / 9 7/8"



V04-160-26
 26 cm / 10 2/8"



Organ Grasping Forceps
 Organfasszangen
 Pinzas para sacar órganos
 Pinces pour saisir organes
 Pinze per afferrare organi



Collin
V04-161-14
 14 cm / 5 4/8"

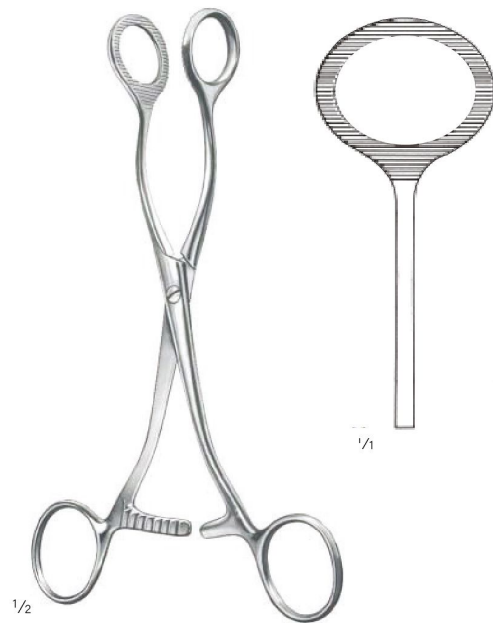

Collin
V04-162-17
 17 cm / 6 5/8"
 Tumorfasszange
 Tumor Grasping Forceps
 Pinzas para sacar órganos
 Pinces à tumeurs à vis
 Pinze per afferrare tumori

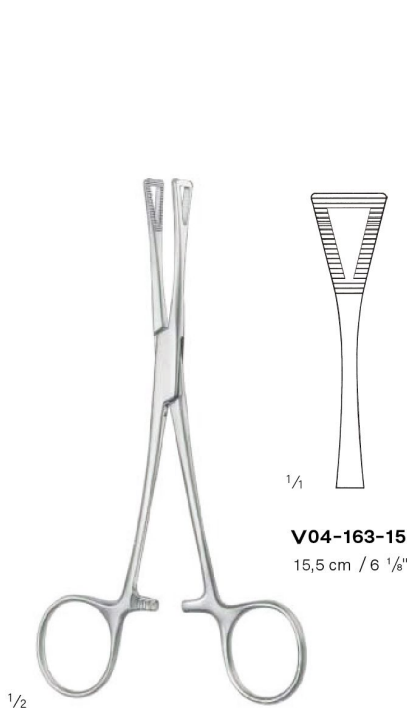

Pennington
V04-163-15
V04-163-21

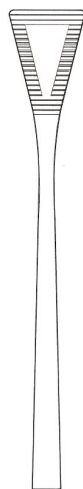

V04-163-15
 15,5 cm / 6 1/8"

V04-163-21
 21 cm / 8 2/8"



Pratt
V04-164-15
 15 cm / 5 7/8"

Haemostatic Forceps, Dissecting and Ligature Forceps
 Arterienklemmen, Präparierklemmen
 Pinzas hemostáticas, Pinzas para preparación y ligadura
 Pinces hémostatiques, Pinces à dissecquer et à ligatures
 Pinze emostatiche, Pinze per preparazioni e legature

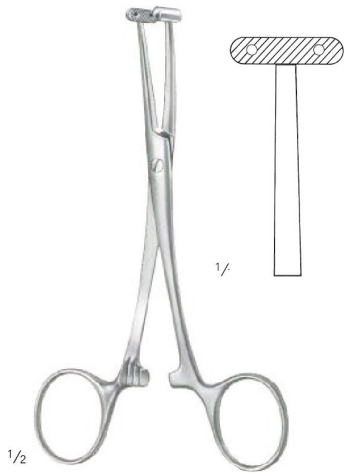

Martel-Rees

V04-165-13

13,5 cm / 5 3/8"
 Face-lift-Klemme
 Face-lift Forceps
 Pinza para Face-lift
 Pinces pour Face-lift
 Pinze per Face-lift



V04-166-12

12,5 cm / 4 7/8"
 Fadenklemme, glattes Maul
 Ligature Forceps, smooth jaw
 Pinza para hilos, boca lisa
 Pince à ligatures, mors lisse
 Pinza per legature, morso liscio



Mixer-Baby

V04-167-13

V04-168-13

13,5 cm / 5 3/8"

13 cm / 5 1/8"



Mikro-Adson

V04-169-14

14 cm / 5 1/2"

1/2

Baby-Adson

V04-170-18

18 cm / 7 1/8"



Haemostatic Forceps
 Arterienklemmen
 Pinzas hemostáticas
 Pinces hémostatiques
 Pinze emostatiche

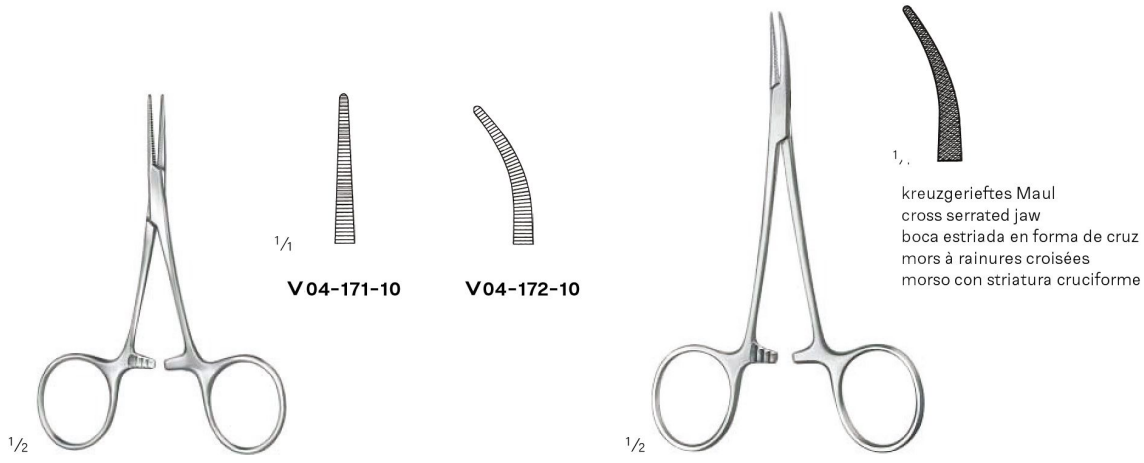

Hartmann
V04-171-10
V04-172-10
 10 cm / 3 7/8"

V04-173-12
 12 cm / 4 9/8"
 Fadenklemme
 Ligature Forceps
 Pinza para hilos
 Pince à ligatures
 Pinza per legature

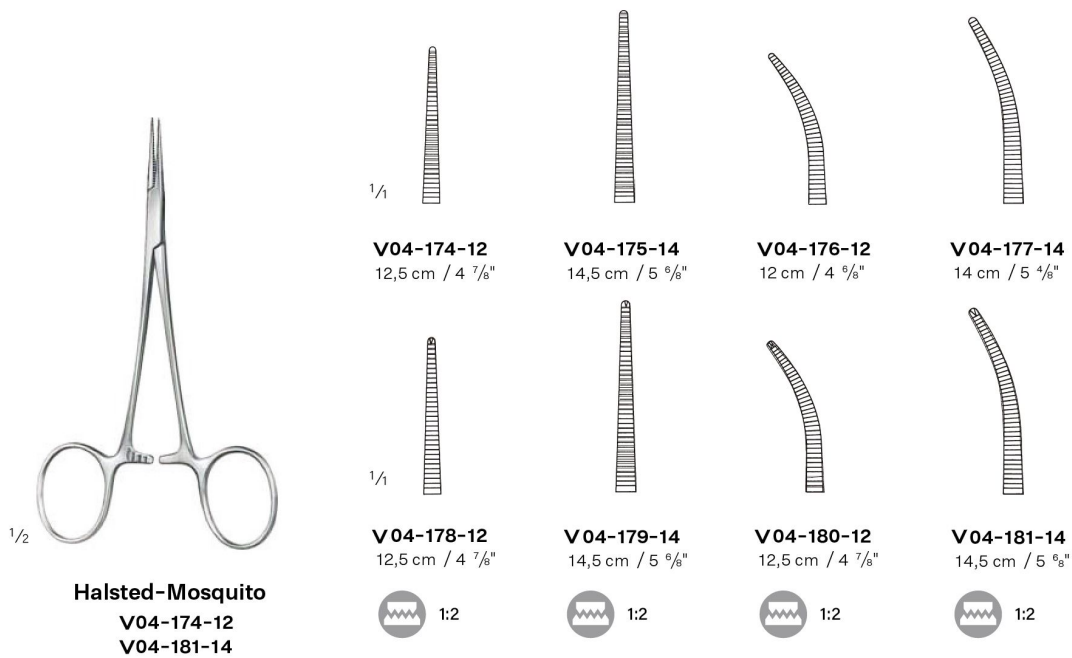

Halsted-Mosquito
V04-174-12
V04-181-14

V04-174-12
 12,5 cm / 4 7/8"

V04-175-14
 14,5 cm / 5 9/8"

V04-176-12
 12 cm / 4 9/8"

V04-177-14
 14 cm / 5 9/8"

V04-178-12
 12,5 cm / 4 7/8"

V04-179-14
 14,5 cm / 5 9/8"

V04-180-12
 12,5 cm / 4 7/8"

V04-181-14
 14,5 cm / 5 9/8"

Haemostatic Forceps
 Arterienklemmen
 Pinzas hemostáticas
 Pinces hémostatiques
 Pinze emostatiche



1/2

Halsted-Mosquito

V04-182-12
 V04-185-12

1/4



V04-182-12
 12,5 cm / 4 7/8"



V04-183-12
 12 cm / 4 6/8"



V04-184-12
 12 cm / 4 6/8"



V04-185-12
 12 cm / 4 6/8"



1/2

Halsted-Mosquito

V04-186-18
 V04-193-20

1/4



V04-186-18
 18,5 cm / 7 2/8"



V04-187-21
 21 cm / 8 2/8"



V04-188-18
 18 cm / 7 1/8"



V04-189-20
 20,5 cm / 8 1/8"

1/4



V04-190-18
 18,5 cm / 7 2/8"



V04-191-21
 21 cm / 8 2/8"



V04-192-18
 18 cm / 7 1/8"



V04-193-20
 20,5 cm / 8 1/8"



Haemostatic Forceps
 Arterienklemmen
 Pinzas hemostáticas
 Pincès hémostatiques
 Pinze emostatiche



1/4

V04-194-10

10 cm / 3 7/8"



V04-195-12

12 cm / 4 5/8"



V04-196-10

10 cm / 3 7/8"



V04-197-12

12 cm / 4 5/8"



1/2

Mikro-Mosquito

V04-194-10

V04-201-12



1/4

V04-198-10

10 cm / 3 7/8"



1:2



V04-199-12

12 cm / 4 5/8"



1:2



V04-200-10

10 cm / 3 7/8"



1:2



V04-201-12

12 cm / 4 5/8"



1:2



1/2

Providence-Hospital

V04-202-14

V04-202-13



1/4

V04-202-14

14 cm / 5 1/2"



V04-202-13

13,5 cm / 5 3/8"



1/2

Leriche

V04-203-15

V04-206-15

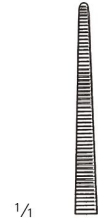

1/4

V04-203-15

15,5 cm / 6 1/8"



V04-204-15

15 cm / 5 7/8"



V04-205-15

15,5 cm / 6 1/8"



1:2

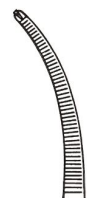

V04-206-15

15 cm / 5 7/8"



1:2

Haemostatic Forceps
 Arterienklemmen
 Pinzas hemostáticas
 Pincès hémostatiques
 Pinze emostatiche



1/2

Kelly
V04-207-14
V04-210-14

1/4

V04-207-14
 14,5 cm / 5 9/16"



V04-208-14
 14,5 cm / 5 9/16"



Ti



V04-209-14
 14 cm / 5 4/8"



V04-210-14
 14 cm / 5 4/8"

Ti



1/2

Dunhill
V04-211-12
 12,5 cm / 4 7/8"

1/4

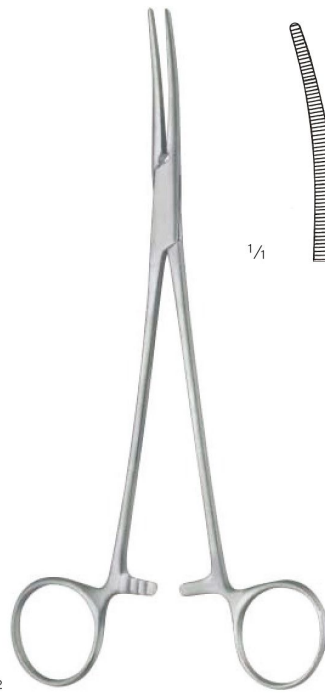

1/2

Dunhill
V04-212-18
 18,5 cm / 7 3/8"

1/4



Haemostatic Forceps, Dissecting and Ligature Forc
 Arterienklemmen, Präparierklemmen
 Pinzas hemostáticas, Pinzas para preparación y ligadu
 Pinces hémostatiques, Pinces à dissequer et à ligatur
 Pinze emostatiche, Pinze per preparazioni e legature



V04-213-16



V04-214-16

Kelly-Rankin

V04-213-16
 V04-214-16

16 cm / 6 2/8"

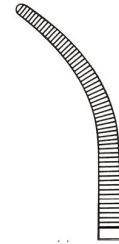

Overholt-Baby

V04-215-13
 13,5 cm / 5 3/8"



V04-216-14



V04-217-14



V04-218-14



V04-219-14



V04-220-14



V04-221-14



Crile

V04-216-14
 V04-221-14

14,5 cm / 5 9/16"



Crile-Rankin
V04-222-16
V04-223-16
 16 cm / 6 3/8"

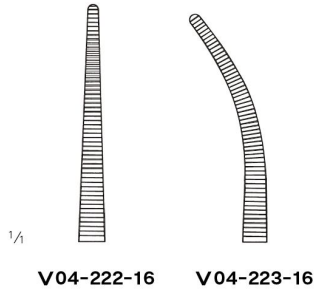

Lovelace
V04-224-16
V04-225-16
 16 cm / 6 3/8"
 kreuzgerieftes Maul
 cross serrated jaw
 boca estriada en forma de cruz
 mors à rainures croisées
 morso con striatura cruciforme

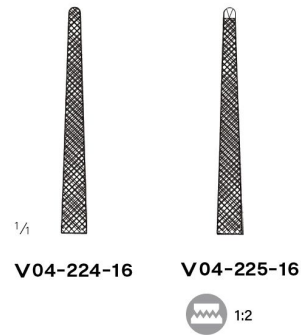

Dandy-Mosquito
V04-226-12
 12 cm / 4 9/16"
 seitlich gebogen
 laterally curved
 curva lateralmente
 courbe lateralement
 curva laterale

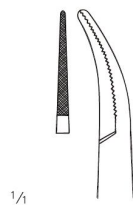

Dandy
V04-227-14
V04-228-14
 14,5 cm / 5 9/16"
 seitlich gebogen
 laterally curved
 curva lateralmente
 courbe lateralement
 curva laterale

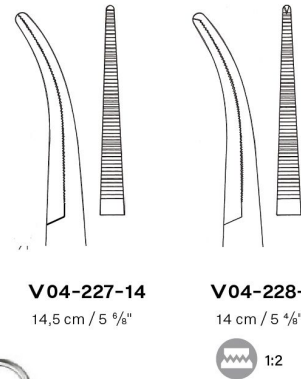



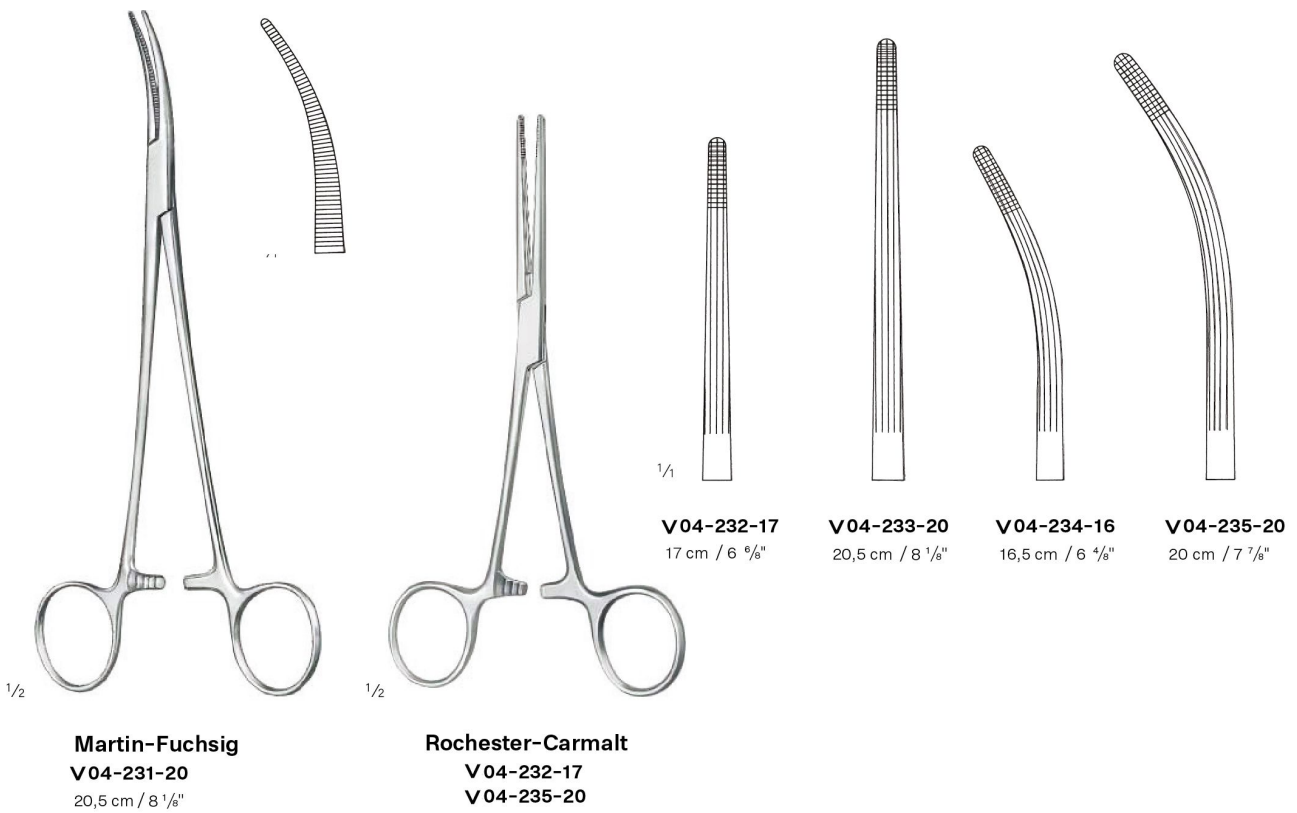
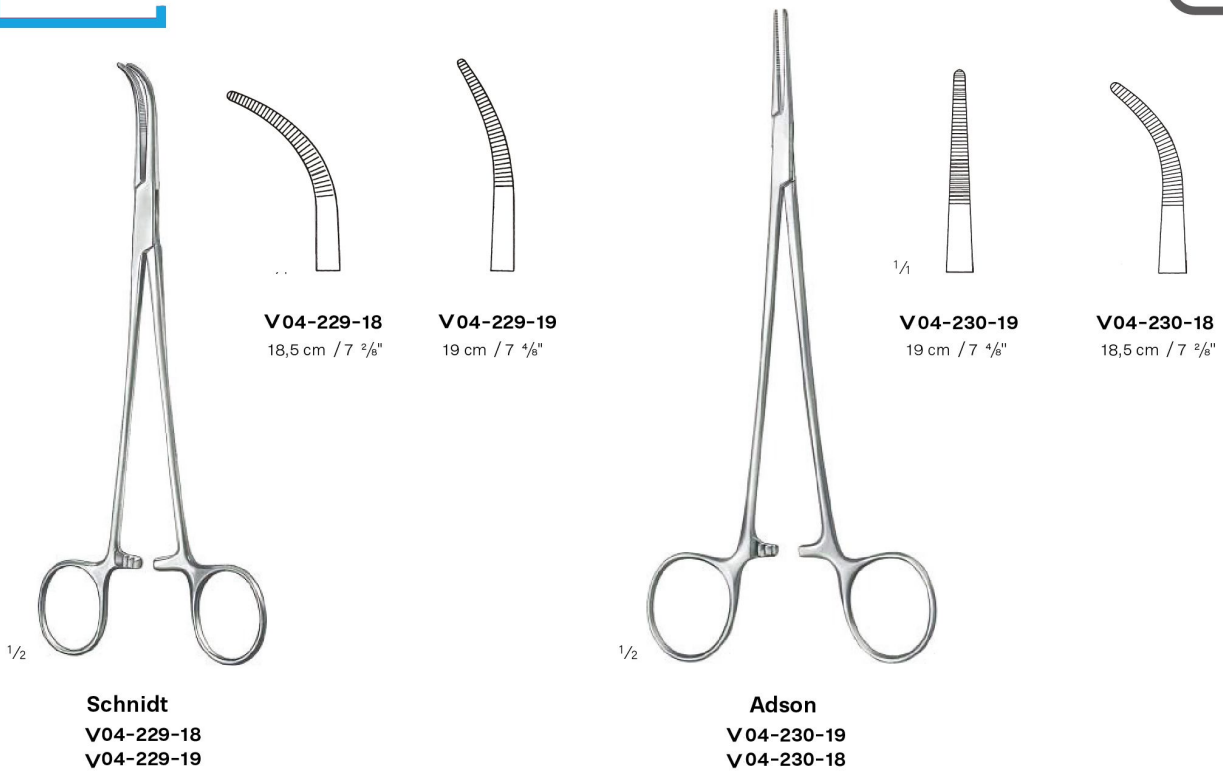



Haemostatic Forceps, Dissecting and Ligature Forc
 Arterienklemmen, Präparierklemmen
 Pinzas hemostáticas, Pinzas para preparación y ligadu
 Pincas hémostáticas, Pincas à dissequer et à ligatur
 Pinze emostatiche, Pinze per preparazioni e legature

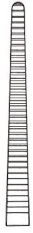

Haemostatic Forceps
 Arterienklemmen
 Pinzas hemostáticas
 Pinces hémostatiques
 Pinze emostatiche









Pean
V04-236-13
V04-241-16

						
	V04-236-13 13,5 cm / 5 3/8"	V04-237-14 14,5 cm / 5 9/16"	V04-238-17 17 cm / 6 5/8"	V04-239-13 13 cm / 5 1/8"	V04-240-14 14 cm / 5 5/8"	V04-241-16 16,5 cm / 6 4/8"



Pean-Nippon
V04-242-14
V04-247-18

						
	V04-242-14 14,5 cm / 5 9/16"	V04-243-16 16,5 cm / 6 4/8"	V04-244-18 18,5 cm / 7 3/8"	V04-245-14 14 cm / 5 4/8"	V04-246-16 16 cm / 6 3/8"	V04-247-18 18 cm / 7 1/8"

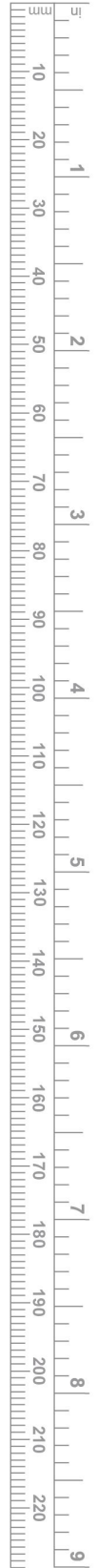

Haemostatic Forceps
 Arterienklemmen
 Pinzas hemostáticas
 Pinces hémostatiques
 Pinze emostatiche



Kocher-Nippon
 V04-248-14
 V04-253-18

1/4 					
V04-248-14 14,5 cm / 5 9/16"	V04-249-16 16,5 cm / 6 4/8"	V04-250-18 18,5 cm / 7 3/8"	V04-251-14 14 cm / 5 4/8"	V04-252-16 16 cm / 6 2/8"	V4-253-18 18 cm / 7 1/8"
1:2	1:2	1:2	1:2	1:2	1:2



Kocher
 V04-254-13
 V04-259-16

1/4 					
V04-254-13 13 cm / 5 1/8"	V04-255-14 14 cm / 5 4/8"	V04-256-16 16 cm / 6 2/8"	V04-257-13 13 cm / 5 1/8"	V04-258-14 14 cm / 5 4/8"	V04-259-16 16 cm / 6 2/8"
1:2	1:2	1:2	1:2	1:2	1:2



Haemostatic Forceps
 Arterienklemmen
 Pinzas hemostáticas
 Pinces hémostatiques
 Pinze emostatiche

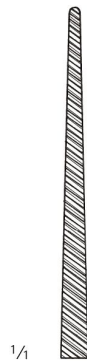

V04-260-21
 21,5 cm / 8 4/8"



V04-261-26
 26 cm / 10 2/8"



V04-262-21
 21,5 cm / 8 4/8"



V04-263-26
 26 cm / 10 2/8"

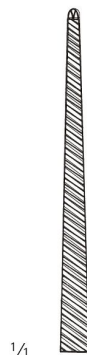

V04-264-21
 21,5 cm / 8 4/8"



V04-265-26
 26 cm / 10 2/8"



V04-266-21
 21,5 cm / 8 4/8"



V04-267-26
 26 cm / 10 2/8"



1/2

Bengolea
V04-260-21
V04-267-26



Haemostatic Forceps
 Arterienklemmen
 Pinzas hemostáticas
 Pinces hémostatiques
 Pinze emostatiche

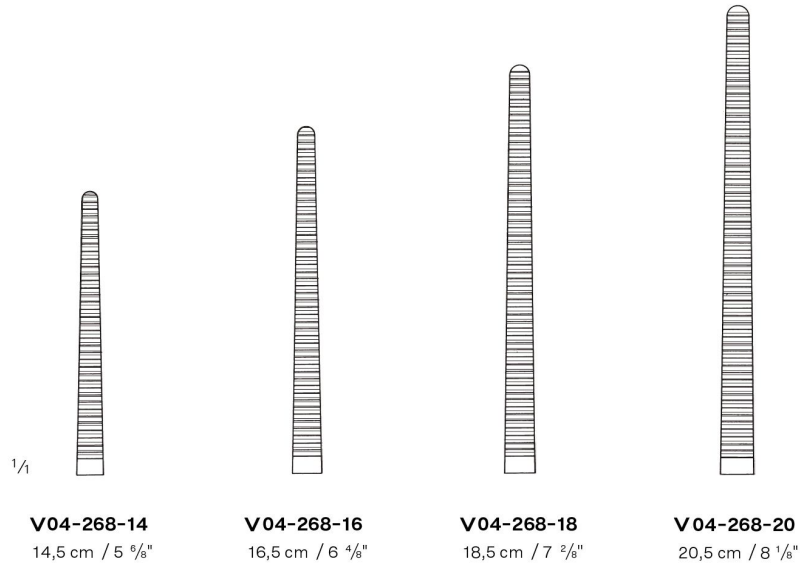

Pean (Rochester)
 V04-268-14
 V04-268-31

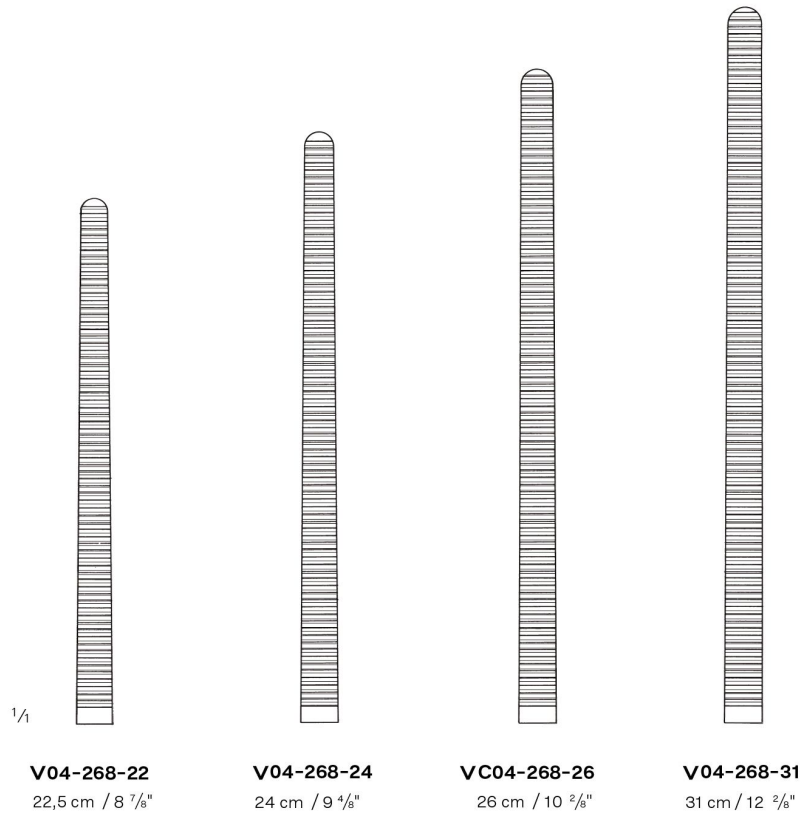

Haemostatic Forceps
 Arterienklemmen
 Pinzas hemostáticas
 Pincas hémostatiques
 Pinze emostatiche



V04-269-14
 14 cm / 5 4/8"

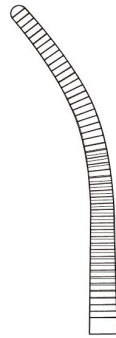

V04-269-16
 16,5 cm / 6 4/8"



V04-269-18
 18,5 cm / 7 2/8"

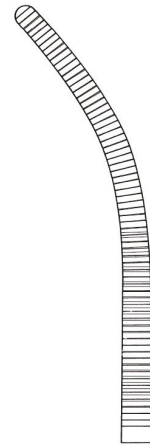

V04-269-20
 20,5 cm / 8 1/8"



1/2

Pean (Rochester)
V04-269-14
V04-269-30

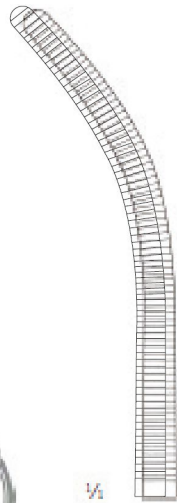

V04-269-22
 22 cm / 8 5/8"

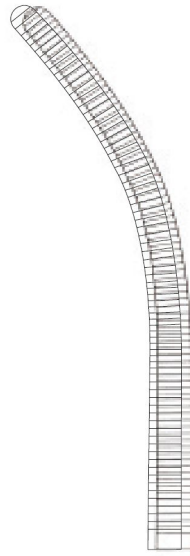

V04-269-24
 24 cm / 9 4/8"

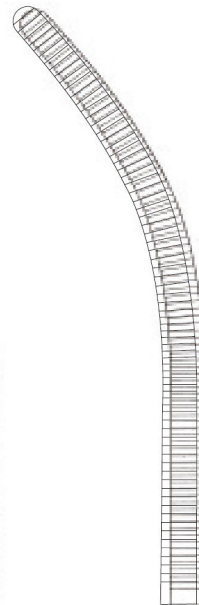

V04-269-26
 26 cm / 10 2/8"

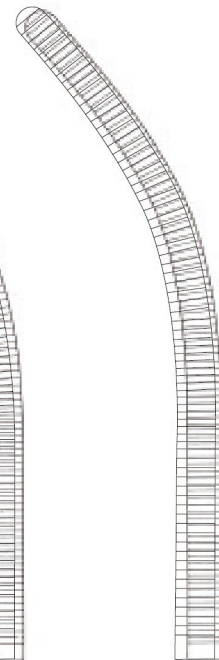

V04-269-30
 30,5 cm / 12"



Haemostatic Forceps
 Arterienklemmen
 Pinzas hemostáticas
 Pinces hémostatiques
 Pinze emostatiche

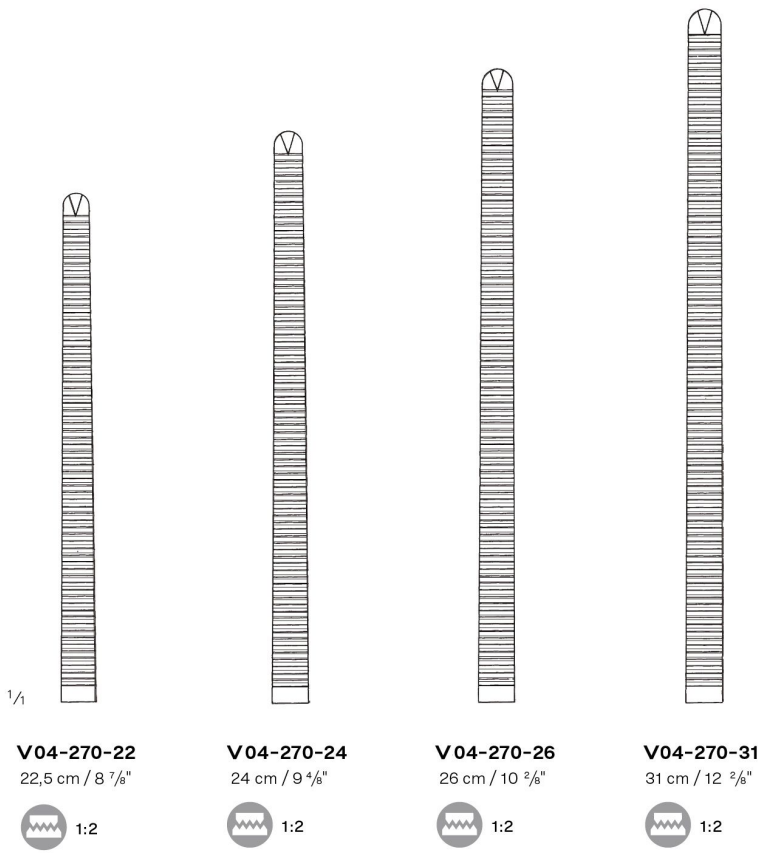
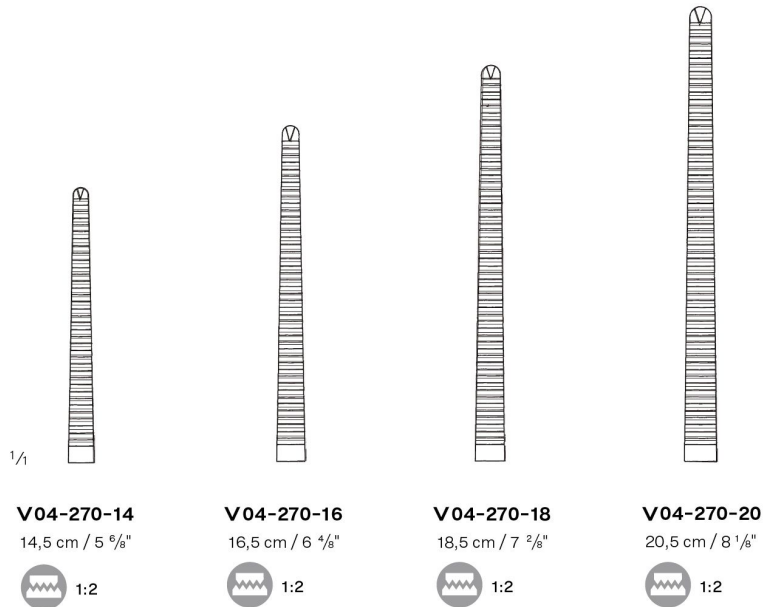

Haemostatic Forceps
 Arterienklemmen
 Pinzas hemostáticas
 Pinces hémostatiques
 Pinze emostatiche



V04-271-14
 14 cm / 5 ⁴/₈"
 1:2



V04-271-16
 16,5 cm / 6 ⁴/₈"
 1:2



V04-271-18
 18,5 cm / 7 ²/₈"
 1:2



V04-271-20
 20 cm / 7 ⁷/₈"
 1:2

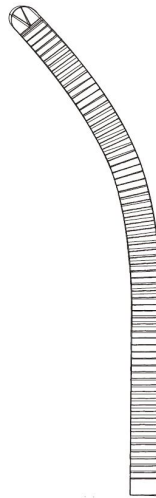

V04-271-22
 22,5 cm / 8 ⁷/₈"
 1:2

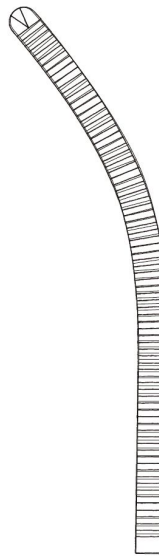

V04-271-24
 24 cm / 9 ⁴/₈"
 1:2

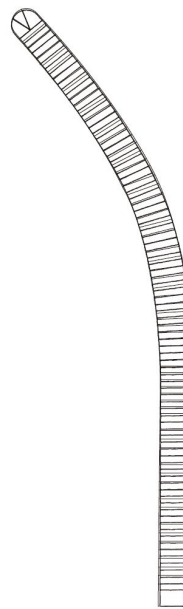

V04-271-26
 26 cm / 10 ²/₈"
 1:2

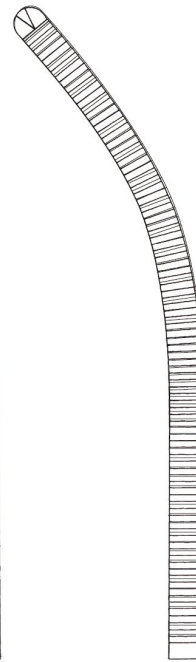

V04-271-30
 30,5 cm / 12"
 1:2



1/2

Kocher (Ochsner)

V04-271-14
V04-271-31

Dissecting and Ligature Forceps
 Präparierklemmen
 Pinzas para preparación y ligadura
 Pincès à disséquer et à ligatures
 Pinze per preparazioni e legature

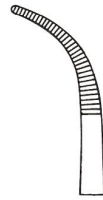

Fig. 1
V04-272-18
 18,5 cm / 7 2/8"

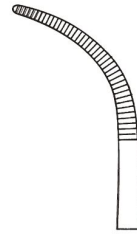

Fig. 2
V04-273-20
 20,5 cm / 8 1/8"

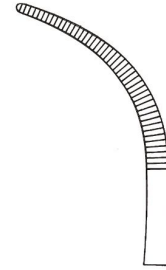

Fig. 3
V04-274-21
 21 cm / 8 2/8"

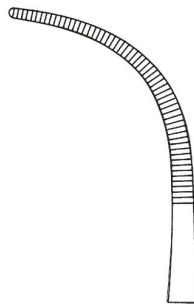

Fig. 4
V04-275-21
 21,5 cm / 8 2/8"

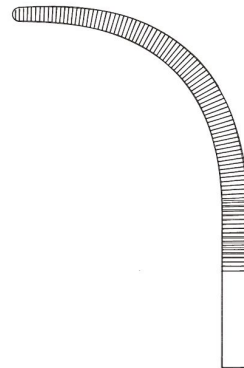

Fig. 5
V04-276-24
 24,5 cm / 9 5/8"



Overholt-Martin
V04-272-18
V04-276-24

1/2

Dissecting and Ligature Forceps

Präparierklemmen
Pinzas para preparación y ligadura
Pinces à disséquer et à ligatures
Pinze per preparazioni e legature



Mixer-Baby
V04-277-18
18,5 cm / 7 2/8"



Adson-Baby
V04-278-14
V04-278-18

V04-278-14
14,5 cm / 5 6/8"

V04-278-18
18 cm / 7 1/8"



Heiss
V04-279-21
V04-281-21

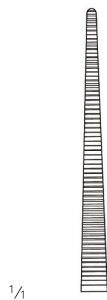

V04-279-21
21 cm / 8 2/8"

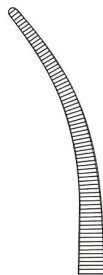

V04-280-20
20,5 cm / 8 1/8"



V04-281-21
21 cm / 8 2/8"



Overholt-Mixer
V04-282-22
22 cm / 8 5/8"



Dissecting and Ligature Forceps
 Präparierklemmen
 Pinzas para preparación y ligadura
 Pincès à disséquer et à ligatures
 Pinze per preparazioni e legature



1/1

V04-283-22
 22,5 cm / 8 7/8"

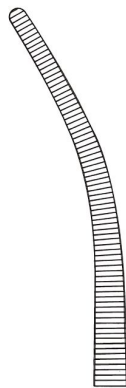

V04-284-22
 22 cm / 8 5/8"

1/2

Roberts
V04-283-22
V04-284-22



1/1

V04-285-25
 25 cm / 9 7/8"

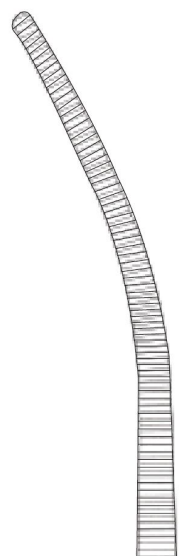

V04-285-24
 24,5 cm / 9 5/8"

1/2

Sarot
V04-285-25
V04-285-24

Dissecting and Ligature Forceps

Präparierklemmen
Pinzas para preparación y ligadura
Pincès à disséquer et à ligatures
Pinze per preparazioni e legature



V04-286-18
18,5 cm / 7 3/8"

Crafoord
V04-286-18
V04-286-24



V04-286-24
24,5 cm / 9 5/8"



V04-287-24
24,5 cm / 9 5/8"

Crafoord-Sellors
V04-287-22
V04-287-24

Gefäßklemme
Vascular clamp
Pinza para vasos
Pince vasculaires
Pinza vascolari

2

Dissecting and Ligature Forceps
 Präparierklemmen
 Pinzas para preparación y ligadura
 Pincas à disséquer et à ligatures
 Pinze per preparazioni e legature

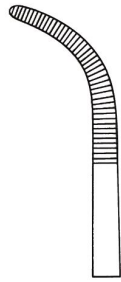

Fig. 1
V04-288-20
 20,5 cm / 8 1/8"

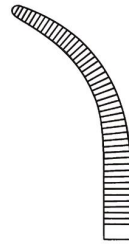

Fig. 2
V04-289-20
 20 cm / 7 7/8"



Fig. 3
V04-290-21
 21,5 cm / 8 4/8"

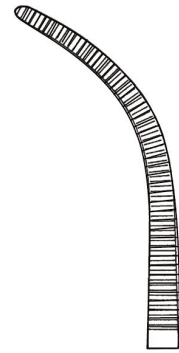

Fig. 4
V04-291-22
 22 cm / 8 5/8"

V04-288-27
 27 cm / 10 5/8"

V04-289-26
 26,5 cm / 10 3/8"

V04-290-27
 27,5 cm / 10 7/8"

V04-291-28
 28 cm / 11"



1/2

Overholt-Geissendörfer

V04-288-20
V04-294-27

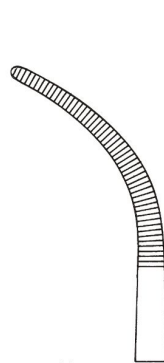

Fig. 5
V04-292-21
 21,5 cm / 8 4/8"

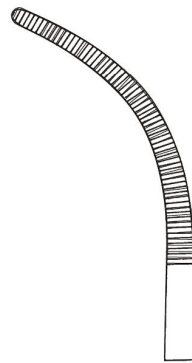

Fig. 6
V04-293-21
 21,5 cm / 8 3/8"



Fig. 7
V04-294-22
 22 cm / 8 5/8"

V04-292-27
 27,5 cm / 10 7/8"

V04-293-28
 28 cm / 11"

V04-294-27
 27,5 cm / 10 7/8"

Dissecting and Ligature Forceps
 Präparierklemmen
 Pinzas para preparación y ligadura
 Pinces à disséquer et à ligatures
 Pinze per preparazioni e legature

finoLine



1/2

Overholt-Fino
V04-295-21
V04-299-22



V04-295-21
 21,5 cm / 8 1/2"

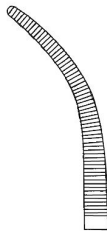

V04-296-22
 22 cm / 8 5/8"

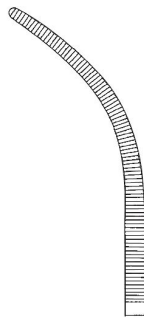

V04-297-22
 22,5 cm / 8 7/8"

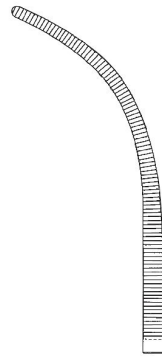

V04-298-23
 23 cm / 9"

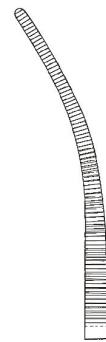

V04-299-22
 22,5 cm / 8 7/8"



Dissecting and Ligature Forceps

Präparierklemmen
Pinzas para preparación y ligadura
Pinces à disséquer et à ligatures
Pinze per preparazioni e legature



V04-300-29
29,5 cm / 11 5/8"

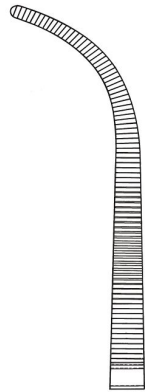

V04-301-29
29,5 cm / 11 5/8"

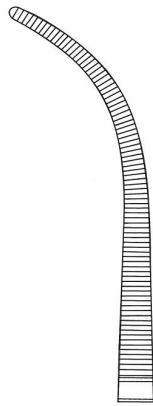

V04-302-30
30 cm / 11 3/8"

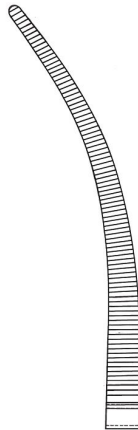

Overholt-Mini
V04-303-15
15 cm / 5 7/8"

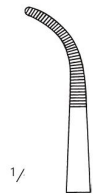

Overholt-Mini
V04-304-20
20 cm / 7 7/8"

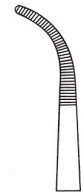

Dissecting and Ligature Forceps

Präparierklemmen
 Pinzas para preparación y ligadura
 Pinces à disséquer et à ligatures
 Pinze per preparazioni e legature



1/2

Gemini
V04-305-13
V04-305-28

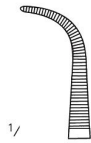

1/4

V04-305-13
 13 cm / 5 1/8"

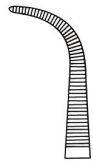

V04-305-16
 16 cm / 6 2/8"



V04-305-18
 18 cm / 7 1/8"



V04-305-21
 21 cm / 8 2/8"

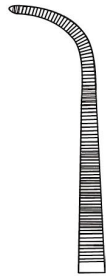

V04-305-23
 23 cm / 9"

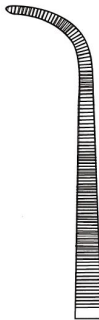

V04-305-25
 25 cm / 9 7/8"

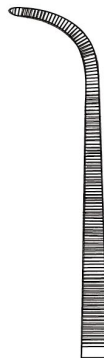

V04-305-28
 28 cm / 11"



1/2

Mini-Gemini
V04-306-18
V04-306-28



1/4

V04-306-18
 18 cm / 7 1/8"



V04-306-23
 23 cm / 9"



V04-306-25
 25 cm / 9 7/8"



V04-306-28
 28,5 cm / 11 2/8"





1/2

Rumel
V04-307-24
V04-311-24

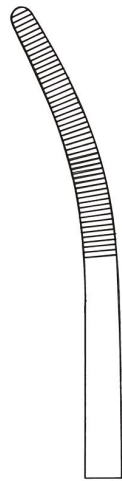

Fig. 1
V04-307-24
 24 cm / 9 4/8"

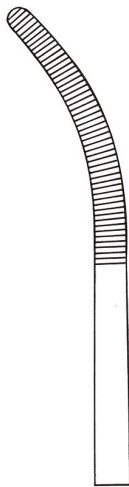

Fig. 2
V04-308-24
 24 cm / 9 4/8"

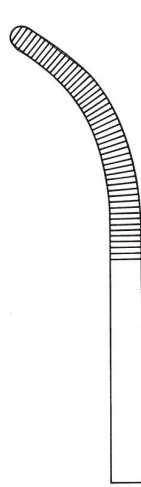

Fig. 3
V04-309-23
 23,5 cm / 9 2/8"

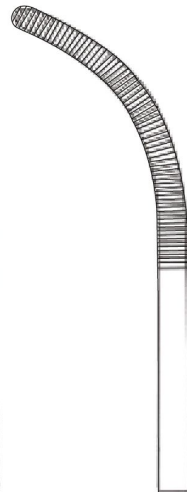

Fig. 4
V04-310-24
 24 cm / 9 4/8"

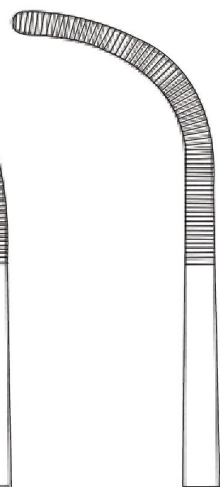

Fig. 5
V04-311-24
 24 cm / 9 4/8"

Dissecting and Ligature Forceps

Präparierklemmen
Pinzas para preparación y ligadura
Pinces à disséquer et à ligatures
Pinze per preparazioni e legature



1/2

Zenker
V04-312-29
V04-312-28

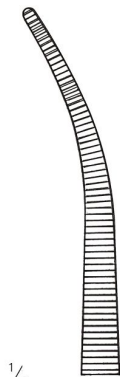

1/2

V04-312-29
29,5 cm / 11 5/8"

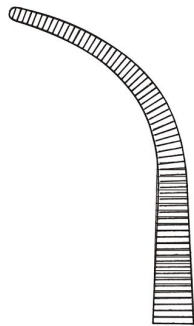

V04-312-28
28,5 cm / 11 2/8"



1/2

Mixer-Baby
V04-313-13
13 cm / 5 1/8"



Dissecting and Ligature Forceps
 Präparierklemmen
 Pinzas para preparación y ligadura
 Pinces à disséquer et à ligatures
 Pinze per preparazioni e legature

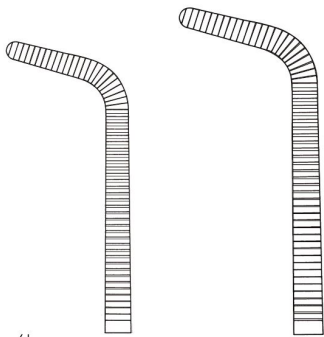

V04-314-16
 16 cm / 6 ²/₈"

V04-314-17
 17,5 cm / 6 ⁷/₈"

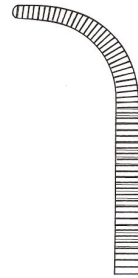

V04-315-15
 15 cm / 5 ⁷/₈"

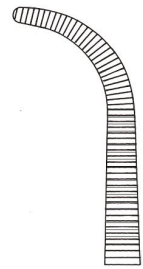

V04-316-18
 18 cm / 7 ¹/₈"



V04-317-18
 18,5 cm / 7 ²/₈"

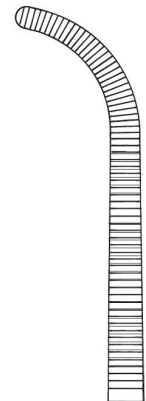

V04-318-20
 20 cm / 7 ⁷/₈"

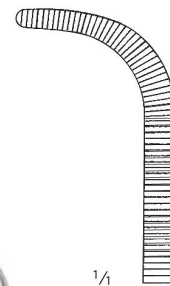

V04-319-23
 23 cm / 9"

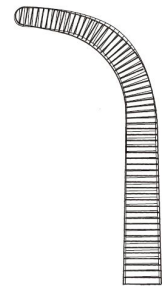

V04-320-26
 26 cm / 10 ²/₈"



Mixer
V04-314-16
V04-314-17



O'Shaughnessy
V04-315-15
V04-320-26



Dissecting and Ligature Forceps
 Präparierklemmen
 Pinzas para preparación y ligadura
 Pinces à disséquer et à ligatures
 Pinze per preparazioni e legature



1/2

Mixer
V04-321-22
 22,5 cm / 8 7/8"

1/2

Mixer
V04-322-23
 23 cm / 9"

1/2

Wikstroem
V04-323-21
V04-323-24

V04-323-21
 21 cm / 8 2/8"

V04-323-24
 24,5 cm / 9 5/8"



Dissecting and Ligature Forceps

Präparierklemmen
Pinzas para preparación y ligadura
Pinces à disséquer et à ligatures
Pinze per preparazioni e legature



V04-324-22
22,5 cm / 8 7/8"

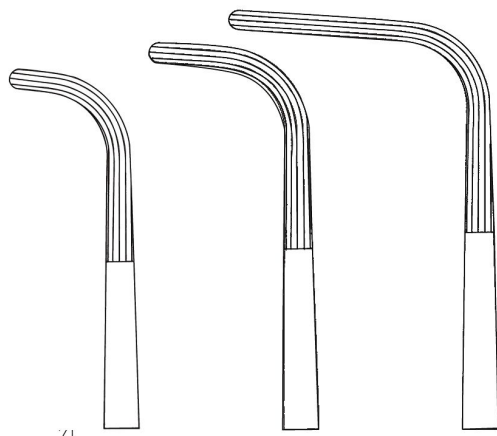

V04-324-26
26 cm / 10 1/8"

V04-324-28
28 cm / 11"

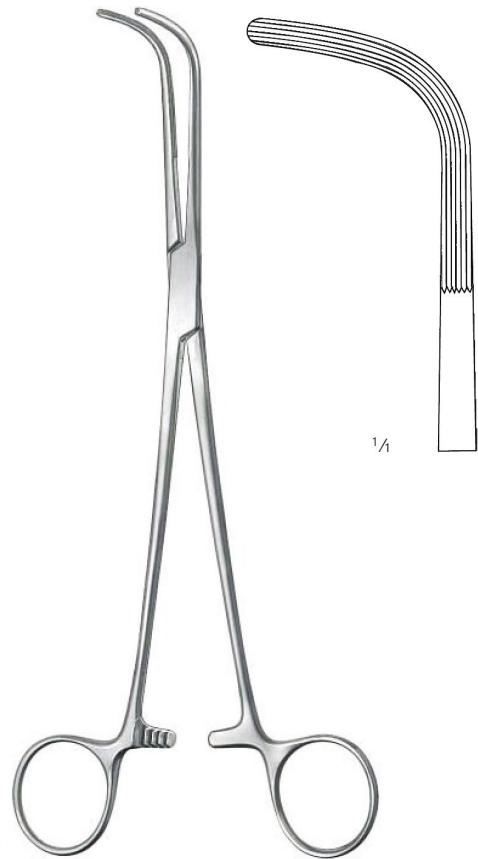

McQuigg-Mixer

V04-325-23
23,5 cm / 9 3/8"



Bile Duct Clamps, Dissecting and Ligature Forceps

Gallenkanalklemmen, Präparierklemmen
Pinzas para conducto biliar, Pinzas para preparación y ligadura
Pincas pour les voies biliaires, Pincas à disséquer et à ligatures
Pinze per vie biliari, Pinze per preparazioni e legature

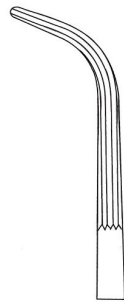

V04-327-19
19,5 cm / 7 5/8"

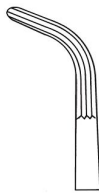

Lower
V04-326-18
18,5 cm / 7 1/4"

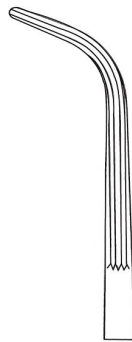

V04-327-22
22,5 cm / 8 7/8"



Lahey
V04-327-19
V04-327-22

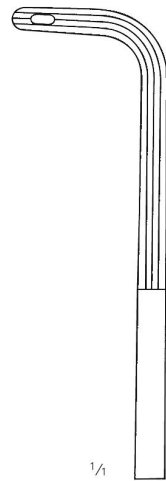

Finochietto
V04-328-24
24,5 cm / 9 5/8"

Tangential Forceps, Kidney Pedicle Clamps

Tangentialklemmen, Nierenstielklemmen

Pinzas tangenciales, Pinzas para pediculo renal

Pinces tangentielles, Pince-clamps pour pédicules rénaux

Pinze tangenziali, Pinze per peduncoli renali

Atrauma

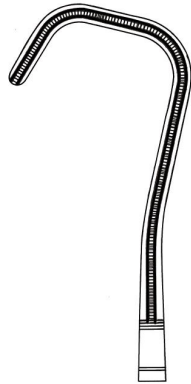
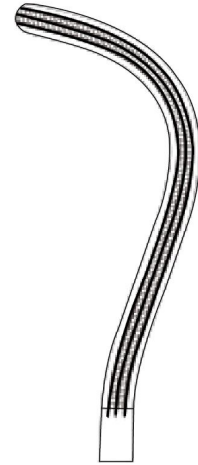

Fig. 1
V04-329-25
25 cm / 9 7/8"



V04-330-23
23 cm / 9"

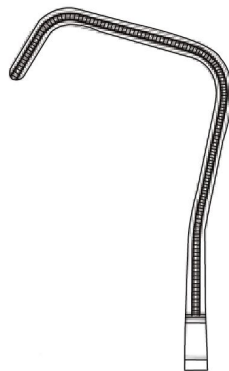
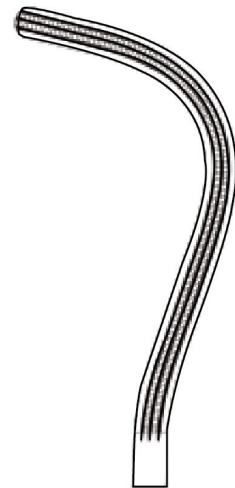

Fig. 2
V04-329-26
26 cm / 10 2/8"



V04-330-24
24 cm / 9 4/8"



1/2

Uro-Tangential

V04-329-25

V04-329-26



1/2

Guyon

V04-330-23

V04-330-24



Kidney Pedicle Clamps

Nierenstielklemmen

Pinzas para pedículo renal

Pince-clamps pour pédicules rénaux

Pinze per peduncoli renali



Guyon
V04-331-19
V04-331-24

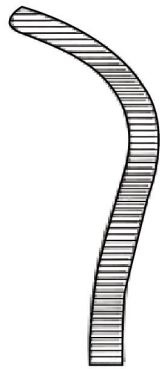

V04-331-19
19,5 cm / 7 5/8"

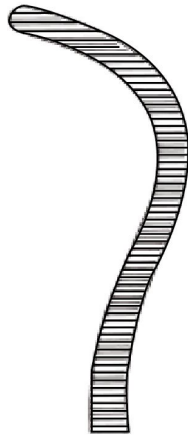

V04-331-21
21,5 cm / 8 1/2"

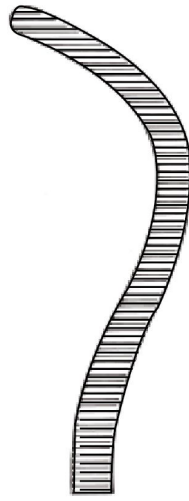

V04-331-24
24,5 cm / 9 5/8"

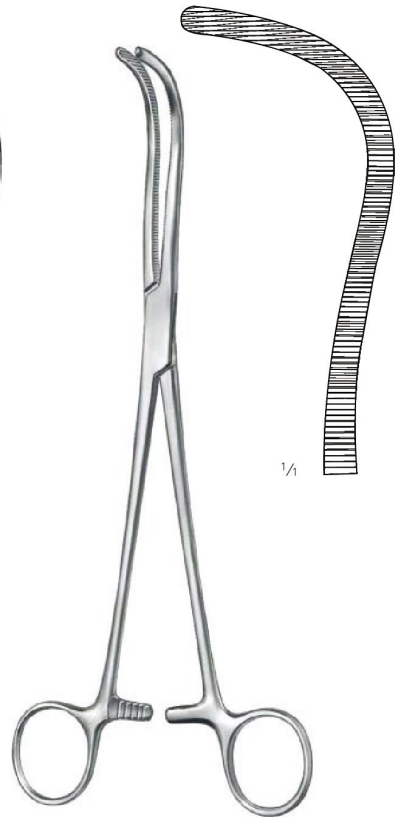

Guyon
V04-332-24
24 cm / 9 1/2"

1/2

1/2



Bile Duct Clamps

Gallenkanalklemmen
Pinzas para conducto biliar
Pincas pour les voies biliaires
Pinze per vie biliari



Desjardins
V04-333-21
21 cm / 8 2/8"



Dissecting and Ligature Forceps

Präparierklemmen
 Pinzas para preparación y ligadura
 Pinces à disséquer et à ligatures
 Pinze per preparazioni e legature

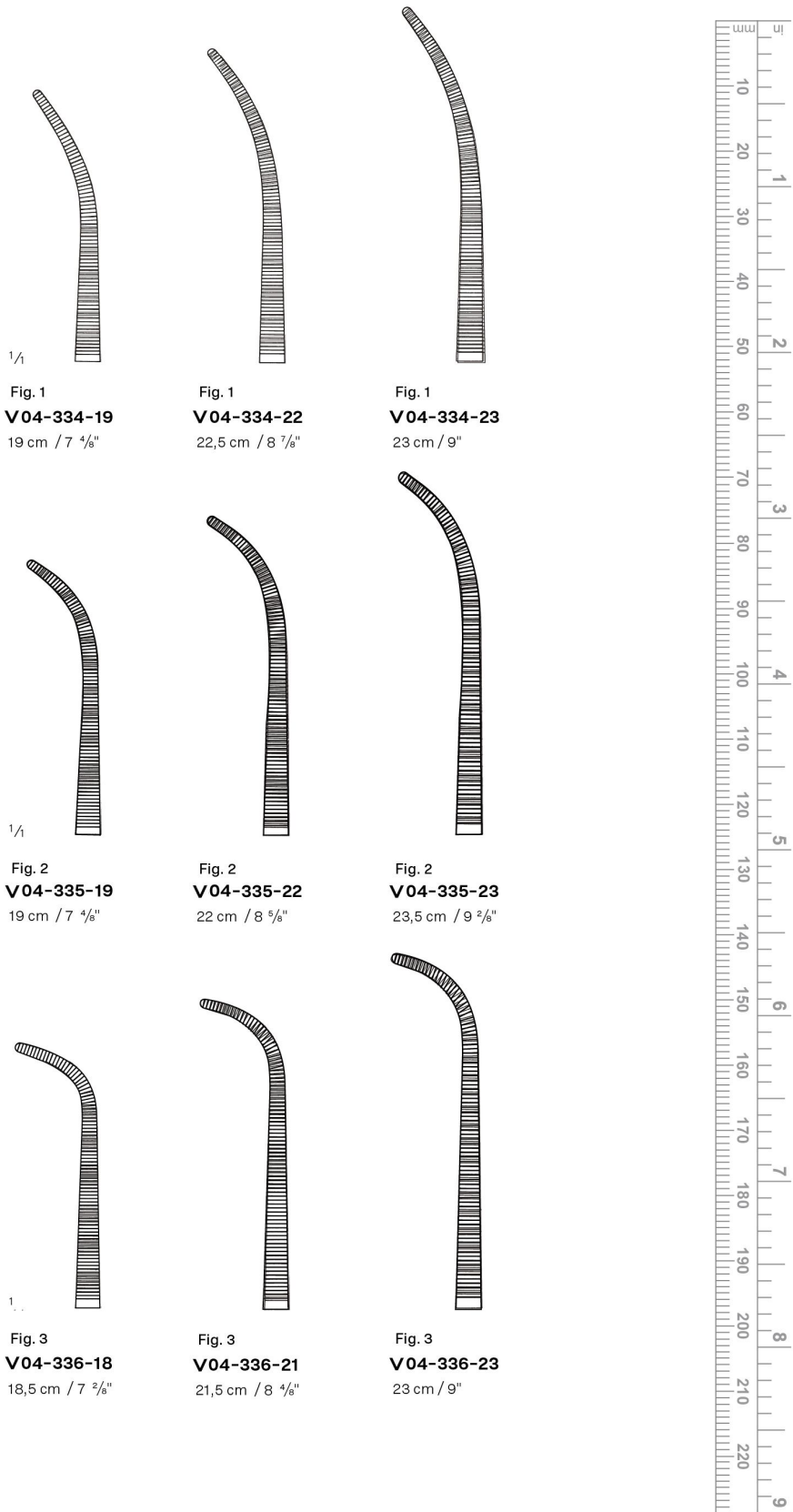

1/4
 Fig. 1
V04-334-19
 19 cm / 7 4/8"

Fig. 1
V04-334-22
 22,5 cm / 8 7/8"

Fig. 1
V04-334-23
 23 cm / 9"

1/4
 Fig. 2
V04-335-19
 19 cm / 7 4/8"

Fig. 2
V04-335-22
 22 cm / 8 5/8"

Fig. 2
V04-335-23
 23,5 cm / 9 2/8"

1/4
 Fig. 3
V04-336-18
 18,5 cm / 7 3/8"

Fig. 3
V04-336-21
 21,5 cm / 8 4/8"

Fig. 3
V04-336-23
 23 cm / 9"



1/2
Kelly
V04-334-19
V04-336-23

Dissecting and Ligature Forceps, Haemostatic Forceps
 Präparierklemmen, Arterienklemmen
 Pinzas para preparación y ligadura, Pinzas hemostáticas
 Pinces à disséquer et à ligatures, Pinces hémostatiques
 Pinze per preparazioni e legature, Pinze emostatiche



Lawrence
V04-337-28
 28 cm / 11"



Meeker
V04-338-28
 28 cm / 11"



Negus
V04-339-19
V04-339-20

Fig. 1
V04-339-19
 19,5 cm / 7 5/8"

Fig. 2
V04-339-20
 20 cm / 7 7/8"

Haemostatic Forceps
 Arterienklemmen
 Pinzas hemostáticas
 Pinces hémostatiques
 Pinze emostatiche



V04-340-20
 20,5 cm / 8 1/8"

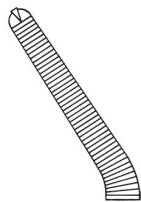

V04-341-20
 20 cm / 7 7/8"



1/2

Phaneuf
V04-340-20
V04-341-20



1/2

Heaney
V04-342-19
V04-343-24



Fig. 1
V04-342-19
 19,5 cm / 7 5/8"



Fig. 1
V04-342-21
 21,5 cm / 8 4/8"



Fig. 1
V04-342-24
 24 cm / 9 4/8"



Fig. 2
V04-343-19
 19,5 cm / 7 5/8"



Fig. 2
V04-343-21
 21,5 cm / 8 4/8"



Fig. 2
V04-343-24
 24 cm / 9 4/8"

Vaginal Clamp
Vaginalklemmen
Pinzas vaginal
Pinces vaginales
Pinza vaginale



1/2

Wertheim-Cullen

V04-344-21

21 cm / 8 2/8"



Hysterectomy Forceps
 Hysterektomieklemmen
 Pinzas para histerectomía
 Pinces à hystérectomie
 Pinze per isterectomia

Atrauma

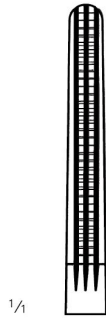

1/4

Fig. 1
V 04-345-21
 21,5 cm / 8 4/8"



Fig. 2
V 04-346-21
 21 cm / 8 2/8"



Fig. 3
V 04-347-21
 21 cm / 8 2/8"

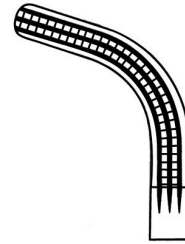
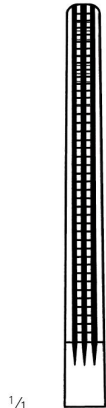

Fig. 4
V 04-348-20
 20,5 cm / 8 1/8"



1/4

Fig. 1
V 04-349-25
 25,5 cm / 10"

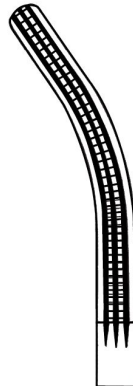

Fig. 2
V 04-350-25
 25 cm / 9 7/8"

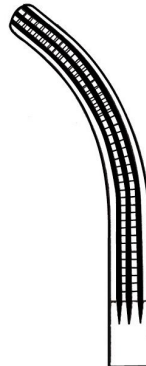

Fig. 3
V 04-351-24
 24,5 cm / 9 4/8"

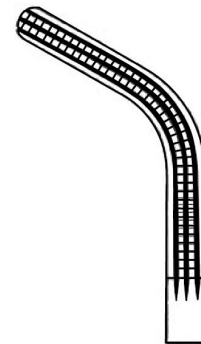

Fig. 4
V 04-352-24
 24,5 cm / 9 4/8"



1/2

Rogers
V 04-345-21
V 04-352-24



Bile Duct Clamps

Gallenkanalklemmen
Pinzas para conducto biliar
Pincas pour les voies biliaires
Pinze per vie biliari



Moynihan
V04-353-23
23 cm / 9"



Moynihan
V04-354-23
23,5 cm / 9 2/8"



Hysterectomy Forceps
 Hysterektomieklemmen
 Pinzas para histerectomía
 Pinces à hystérectomie
 Pinze per isterectomia



Wertheim
V04-355-26
 26 cm / 10 2/8"



Wertheim
V04-356-22
V04-357-22
 22,5 cm / 8 7/8"

V04-356-22



leicht gebogen
 slightly curved
 curva ligera
 courbe légère
 curva leggera

V04-357-22



stärker gebogen
 stronger curved
 curva fuerte
 courbe forte
 curva forte

Peritoneum Forceps
Peritoneumklemmen
Pinzas para peritoneo
Pince pour le péritoine
Pinze per peritoneo



Mikulicz-Baby
V04-358-14
14,5 cm / 5 9/16"



Mikulicz
V04-359-18
18,5 cm / 7 3/8"



Mikulicz
V04-360-20
20 cm / 7 7/8"

Peritoneum Forceps
 Peritoneumklemmen
 Pinzas para peritoneo
 Pince pour le péritoine
 Pinze per peritoneo



Mikulicz
V04-361-20
 20 cm / 7 7/8"

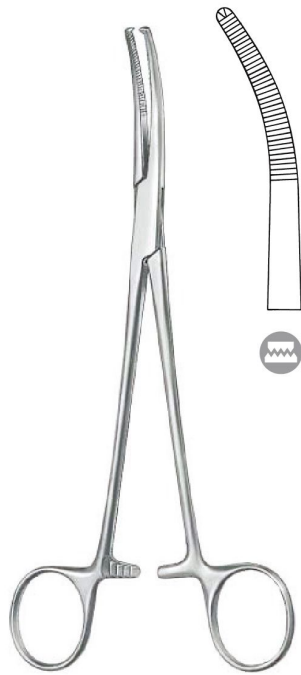

Mikulicz
V04-362-20
 20,5 cm / 8 1/8"



Faure
V04-363-21
V04-364-21
 21 cm / 8 2/8"

Towel Clamps

Tuchklemmen
Pinzas de campo
Pinces à champs
Pinze fissatele



1/2

Schädel

V04-365-09

9 cm / 3 4/8"

scharf
sharp
agudo
pointu
acuto



1/2

Jones

V04-366-05

V04-366-05

5,5 cm / 2 1/8"

V04-366-08

V04-366-08

8,5 cm / 3 3/8"

scharf
sharp
agudo
pointu
acuto



1/2

Jones-Martin

V04-367-08

8,5 cm / 3 3/8"

scharf, mit Schlauchhalter
sharp, with tube holder
agudo, con porta-tubo
pointu, avec clamp porte-tube
acuto, con porta-tubo



1/2

Backhaus

V04-368-11

V04-368-13

graziles Modell, scharf
delicate model, sharp
modelo delicado, aguda
modèle gracile, aiguë
modello delicato, acuto

V04-368-11

11 cm / 4 3/8"

V04-368-13

13 cm / 5 1/8"



1/2

Backhaus

V04-370-09

V04-370-16

scharf
sharp
agudo
pointu
acuto



V04-370-09

9 cm / 3 4/8"

V04-370-11

11 cm / 4 3/8"

V04-370-13

13 cm / 5 1/8"

V04-370-16

16 cm / 6 2/8"



Towel Clamps

Tuchklemmen
Pinzas de campo
Pincas à champs
Pinze fissatele



Peers-Bertram modif.
V04-371-14

14,5 cm / 5 9/16"

weites Maul zur Schlauchfixierung
wide jaw for tube fixation
boca ancha para fijación de tubos
mors large pour fixation de tube
morso spalancato per fissare il tubo

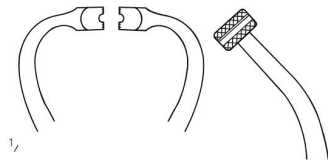

Roeder
V04-372-13

13,5 cm / 5 3/8"



V04-373-10
10 cm / 3 7/8"

V04-373-13
13 cm / 5 1/8"

Lorna
V04-373-10
V04-373-13

fein gezahnt, breites Maul
fine serration, wide jaw
delicadamente dentada, boca ancha
avec dents fins, mors large
con denti fini, morso largo



Bernhard
V04-374-16

16,5 cm / 6 4/8"

scharf
sharp
agudo
pointu
acuto

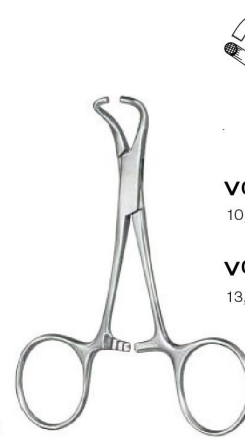

V04-375-10
10,5 cm / 4 1/8"

V04-375-13
13,5 cm / 5 3/8"

Tohoku
V04-375-10
V04-375-13

stumpf
blunt
romo
mousse



Towel Clamps, Tubing Clamps

Tuchklemmen, Schlauchklemmen
Pinzas de campo, Pinzas para tubos
Pincas à champs, Pincas presse-tubes
Pinze fissatele, Pinze serratubi

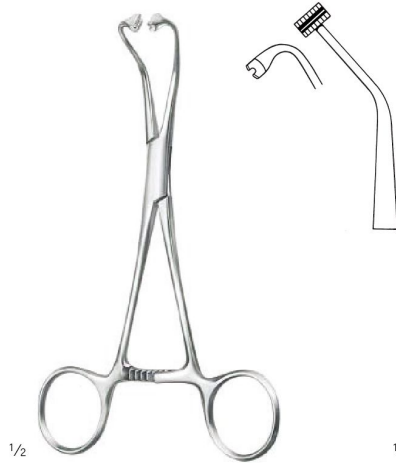

Peers-Bertram
V04-376-14
14,5 cm / 5 ⁵/₈"

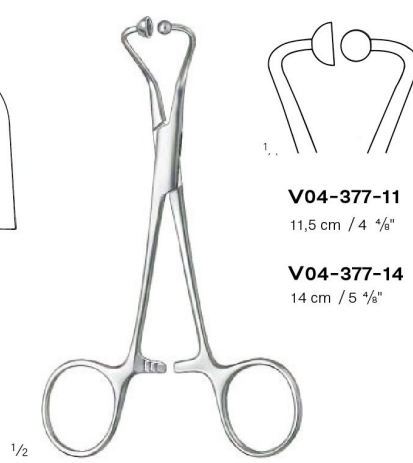

V04-377-11
11,5 cm / 4 ¹/₈"

V04-377-14
14 cm / 5 ¹/₈"



Lane
V04-378-19
19,5 cm / 7 ⁵/₈"

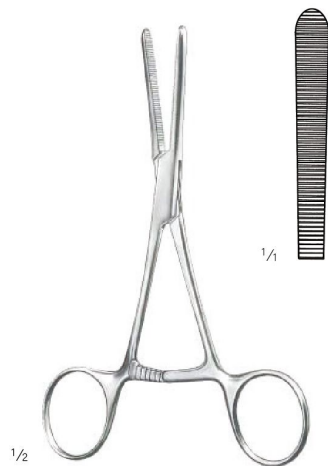

V04-379-14
14 cm / 5 ¹/₈"
extra lange Sperre
extra long ratchet
cremallera extra larga
cremaillère extrêmement longue
cremagliera stralunga

V04-377-11
V04-377-14
für Papierabdeckung
for paper drapes
para paños de papel
pour couverture en papier
per copertura di carta

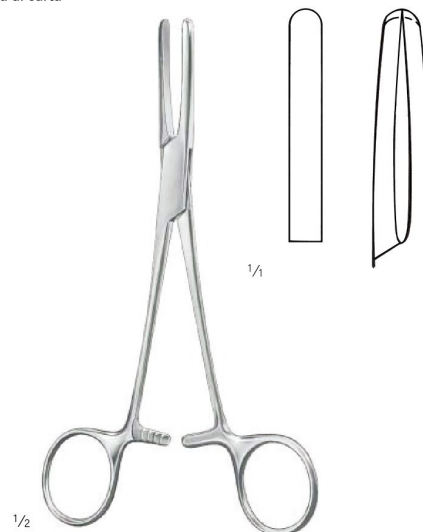

V04-380-16
16,5 cm / 6 ¹/₈"
glattes Maul
smooth jaw
boca lisa
mors lisse
morso liscio

Tubing Clamps

Schlauchklemmen
Pinzas para tubos
Pincers presse-tubes
Pinze serratubi



1/2



1/1

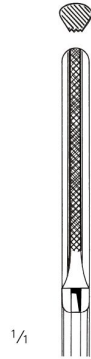

1/1

V04-381-15
15,5 cm / 6 1/8"

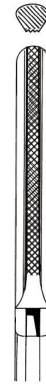

V04-381-19
19 cm / 7 4/8"



V04-381-20
20,5 cm / 8 1/8"

V04-381-15
V04-381-20



1/2



1/1

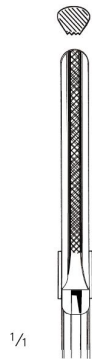

1/1

V04-382-15
15,5 cm / 6 1/8"

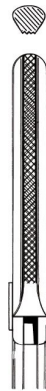

V04-382-19
19 cm / 7 4/8"



V04-382-20
20,5 cm / 8 1/8"

V04-382-19
V04-382-20

mit Schutzbügel
with safety guard
con stribo de protección
avec protection
con protezone

Tubing Clamps

Schlauchklemmen
Pinzas para tubos
Pincas presse-tubes
Pinze serratubi



1/2

Gunnar-Hey
V04-384-18
18 cm / 7 1/8"



no one does it BETTER



Cell: +92 334 6113800

URL: <https://vorlinginstruments.com>

Email: info@vorlinginstruments.com

Address:

Kacha Shahab Pura Road

Jeewan Pura, Sialkot (51310)

Pakistan.

