

DELIVERS WELL-BEING

• BOOSTING
CONFIDENCE
IN FLAWLESS
PROCEDURES



FORCEPS +



An Era Of **evolution**

VORLING
instruments

HAS THE REPUTATION OF BEING THE ONLY IN PAKISTAN THAT MANUFACTURES ITS OWN TOOLS FOR THE PRODUCTION OF ITS INSTRUMENTS.

VORLING instruments is a privately owned company providing personalized services and the finest in Surgical Instruments for over 25 years. Established in 1999, Our Company manufactures a wide range of Surgical, Dental and Veterinary Instruments.

All Instruments and devices of our product range are manufactured by well-trained and experienced skilled workers with special craftsmanship and by use of most modern machines and equipment. On this occasion we only use materials which meet our high standards. The CEO of Vorling Instruments, Mr. Muhammad Ahmed brings with him a lifetime of knowledge about the world of surgical instruments.

This insight allows us to understand the needs of our customers in a way most other instrument companies are unable to do.

After becoming a competent oem service provider, cardiac has decided to introduce itself as the original source of high quality instrumentation to directly interact with some of the well-known brands around the world.



1/2

V03-100-10
 to

V03-100-23

Standardmodell
 standard pattern
 modelo estándar
 modèle standard
 modello standard

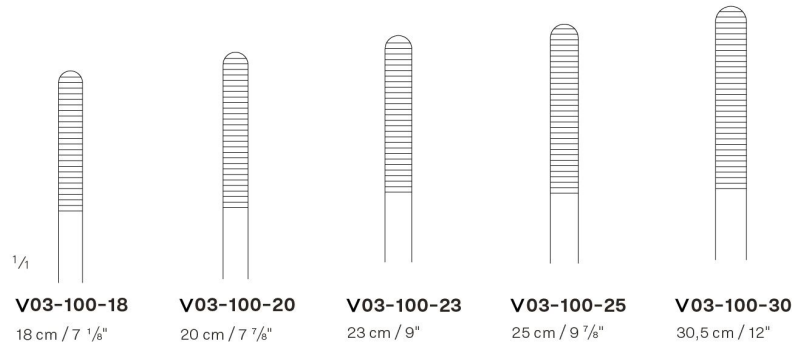
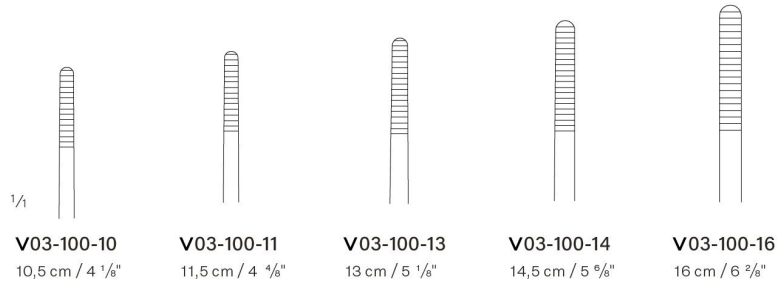

1/2

V03-101-12
 to

V03-101-30

mittelbreit
 medium width
 de anchura medio
 demi-large
 di media larghezza

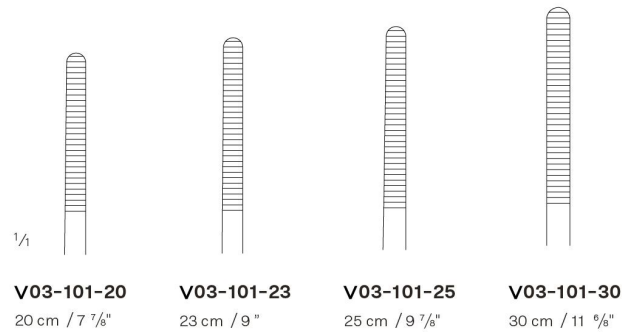
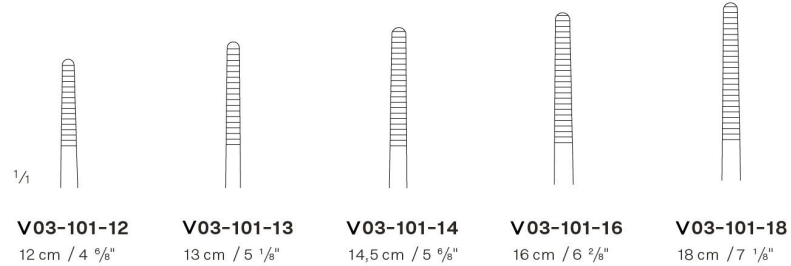

Dissecting Forceps
 Anatomische Pinzetten
 Pinzas de disección
 Pinces à dissection
 Pinze per dissezione

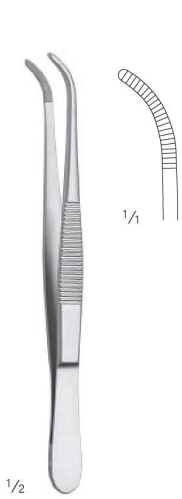

V03-102-13
 13 cm / 5 1/8"

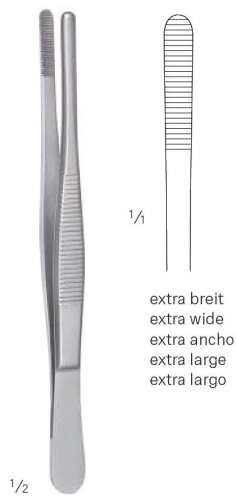

V03-103-14
 14,5 cm / 5 9/16"

extra breit
 extra wide
 extra ancho
 extra large
 extra largo



V03-104-13
V03-104-14

V03-104-13
 13 cm / 5 1/8"

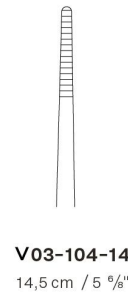

V03-104-14
 14,5 cm / 5 9/16"

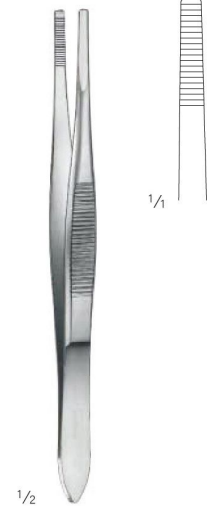

Stille
V03-105-15
 15 cm / 5 7/8"

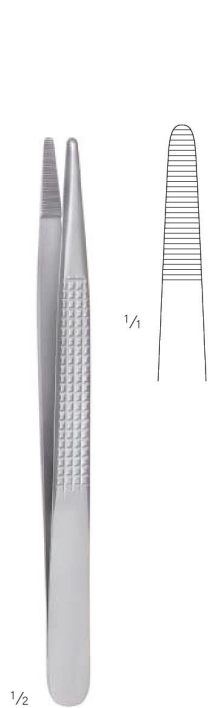

Bonney
V03-106-17
 17 cm / 6 5/8"



V03-107-18
 18,5 cm / 7 2/8"



Brophy
V03-108-20
 20 cm / 7 7/8"



V03-109-20
 20 cm / 7 7/8"



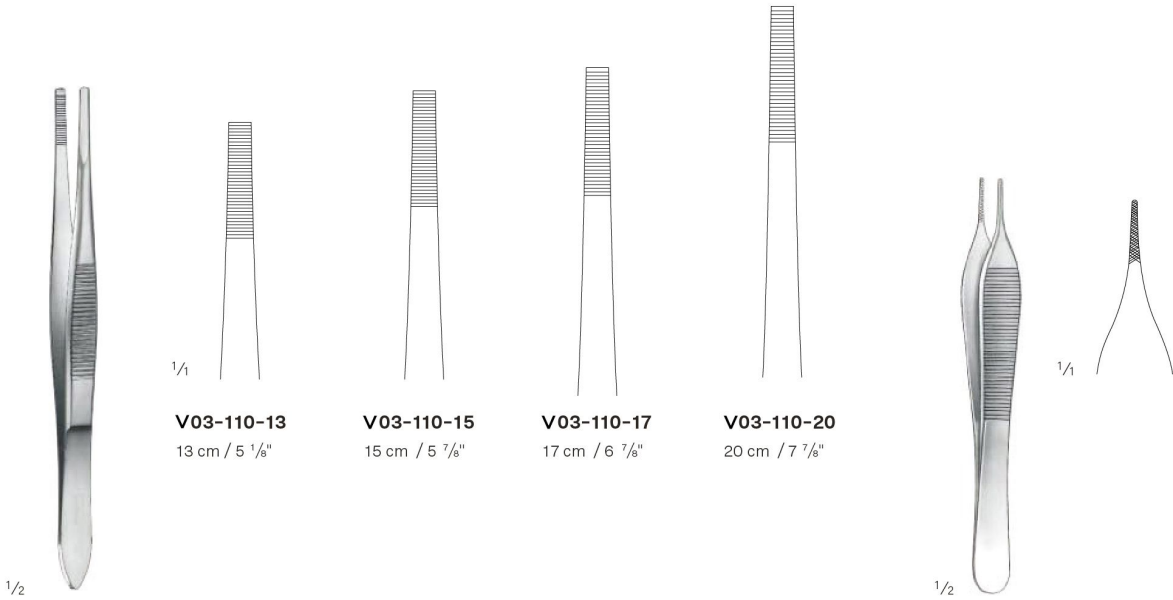

Schweden-Modell
 V03-110-13
 to
 V03-110-20

Mini-Adson
 V03-111-12
 12 cm / 4 5/8"

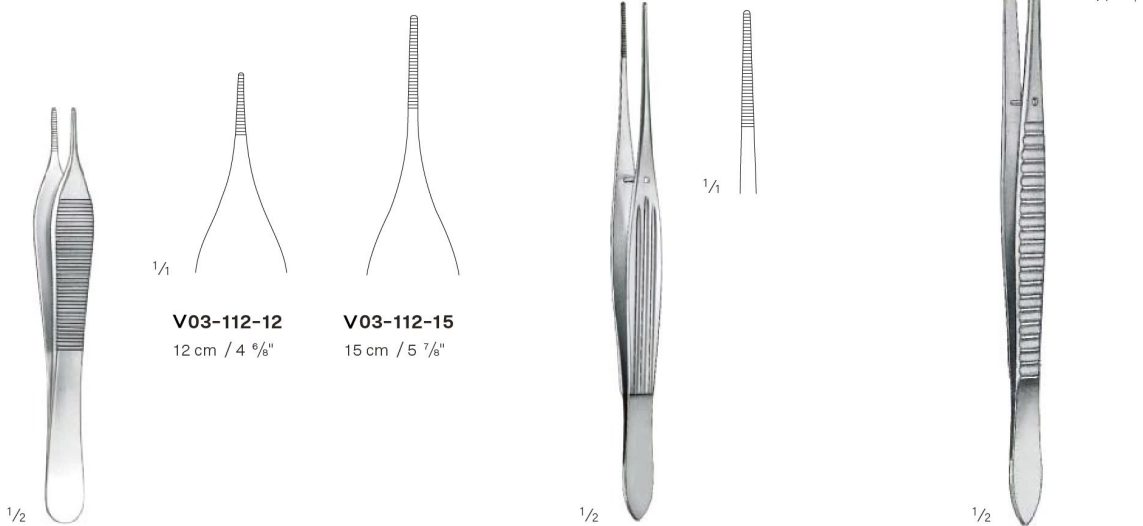

Adson
 V03-112-12
 V03-112-15

McIndoe
 V03-113-15
 15 cm / 5 7/8"

Waugh
 V03-114-20
 20 cm / 7 7/8"

Dissecting Forceps
 Anatomische Pinzetten
 Pinzas de disección
 Pincès à dissection
 Pinze per dissezione

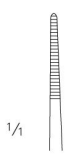

V03-115-12
 12,5 cm / 4 7/8"

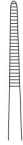

V03-115-15
 15 cm / 5 7/8"



V03-116-15
 0,6 mm



V03-117-15
 0,8 mm



V03-118-15
 1,0 mm

Semken
V03-115-12
V03-115-15

V03-116-15
 to
V03-118-15
 15,5 cm / 6 1/8"



Taylor
V03-119-17
 17 cm / 6 5/8"



Taylor
V03-120-17
 17,5 cm / 6 7/8"
 mit Schaberende
 with dissector end
 con rascador
 à rugine
 con estremita a forma di raschino



Taylor
V03-121-18
 18,5 cm / 7 2/8"
 mit Schaberende
 with dissector end
 con rascador
 à rugine
 con estremita a forma di raschino

Dissecting Forceps
 Anatomische Pinzetten
 Pinzas de disección
 Pincers à dissection
 Pinze per dissezione

Atrauma



V03-122-17
 17,5 cm / 6 7/8"



Gerald
V03-123-17
V03-124-17

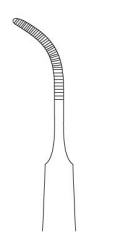

V03-124-17
 17 cm / 6 5/8"

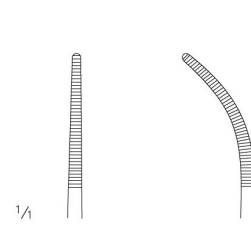

Cushing
V03-125-17
V03-126-17



V03-125-17
 17,5 cm / 6 7/8"

V03-126-17
 17 cm / 6 5/8"



Potts-Smith
V03-127-18
 to
V03-127-30

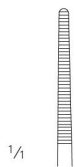

V03-127-18
 18 cm / 7 1/8"



V03-127-21
 21 cm / 8 2/8"



V03-127-25
 25 cm / 9 7/8"



V03-127-30
 30 cm / 11 5/8"

Tissue Forceps, Dissecting Forceps

Chirurgische Pinzetten, Anatomische Pinzetter
 Pinzas de disección con diente, Pinzas de disección
 Pincès à dissection à griffes, Pincès à dissection
 Pinze per dissezione con denti, Pinze per dissezione



TC GOLD



1/2

Bonney
V03-128-17
 17,5 cm / 6 7/8"
 Normalprofil
 standard profile
 perfil estándar
 profil normal
 profilo normale

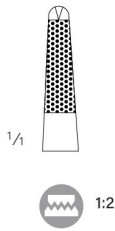

1/4

1:2



1/2

Gerald
V03-129-17
 17,5 cm / 6 7/8"
 Normalprofil
 standard profile
 perfil estándar
 profil normal
 profilo normale

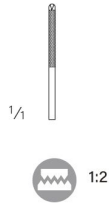

1/4

1:2



1/2

Gillies
V03-130-15
 15,5 cm / 6 1/8"
 Miniprofil
 mini profile
 perfil mini
 profil mini
 mini-profilo

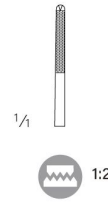

1/4

1:2



1/2

McIndoe
V03-131-15
 15 cm / 5 7/8"
 Miniprofil
 mini profile
 perfil mini
 profil mini
 mini-profilo



1/4



1/2

Semken
V03-132-15
 to
V03-134-17

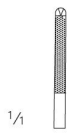

1/4

V03-132-15
 15,5 cm / 6 1/8"
 Normalprofil
 normal profile
 perfil normal
 profil normal
 profilo normale



1:2

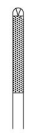

V03-133-17
 17,5 cm / 6 7/8"
 Normalprofil
 normal profile
 perfil normal
 profil normal
 profilo normale



1:2



V03-134-15
 15,5 cm / 6 1/8"
 Miniprofil
 mini profile
 perfil mini
 profil mini
 mini-profilo



1:2

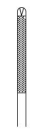

V03-135-17
 17,5 cm / 6 7/8"
 Miniprofil
 mini profile
 perfil mini
 profil mini
 mini-profilo



1:2

Tissue Forceps, Dissecting Forceps

Chirurgische Pinzetten, Anatomische Pinzetten
 Pinzas de disección con diente, Pinzas de disección
 Pincers à dissection à griffes, Pincers à dissection
 Pinze per dissezione con denti, Pinze per dissezione

TC GOLD



Adson-Brown

V03-136-12

12 cm / 4 9/16"

Normalprofil
 normal profile
 perfil normal
 profil normal
 profilo normale



Adson

V03-137-12

V03-137-15

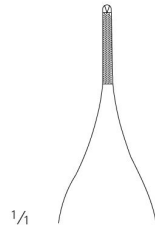

V03-137-12

12 cm / 4 9/16"

Miniprofil
 mini profile
 perfil mini
 profil mini
 mini-profilo

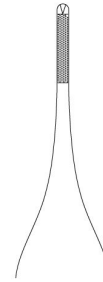

V03-137-15

15 cm / 5 7/8"

Miniprofil
 mini profile
 perfil mini
 profil mini
 mini-profilo



Adson

V03-138-12

V03-142-15

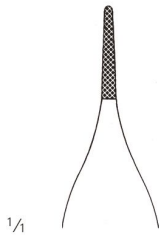

V03-138-12

12 cm / 4 9/16"

Normalprofil
 normal profile
 perfil normal
 profil normal
 profilo normale



V03-139-15

15 cm / 5 7/8"

Normalprofil
 normal profile
 perfil normal
 profil normal
 profilo normale



V03-141-12

12 cm / 4 9/16"

Normalprofil
 normal profile
 perfil normal
 profil normal
 profilo normale



V03-142-15

15 cm / 5 7/8"

Normalprofil
 normal profile
 perfil normal
 profil normal
 profilo normale



Dissecting Forceps
 Anatomische Pinzetten
 Pinzas de disección
 Pincès à dissection
 Pinze per dissezione

TC GOLD

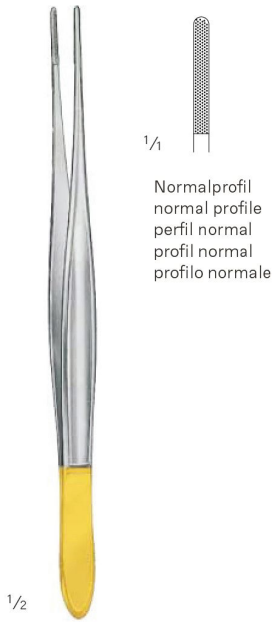

Cushing
V03-143-17
 17,5 cm / 6 7/8"



Cushing
V03-144-17
 17 cm / 6 5/8"

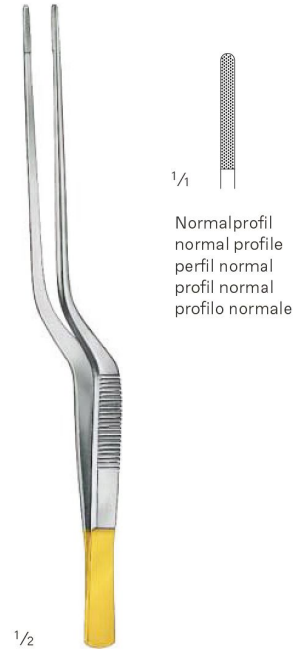

Cushing-Taylor
V03-145-18
 18,5 cm / 7 3/8"

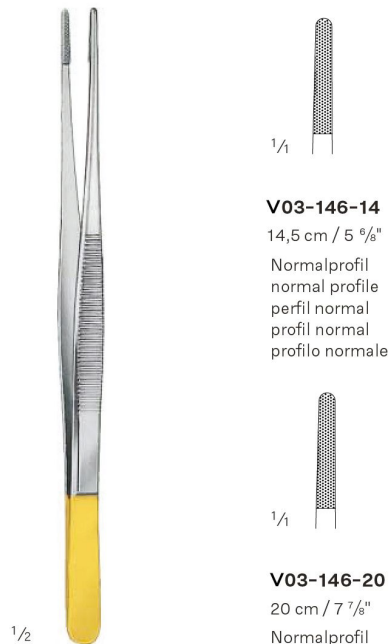

Potts-Smith
V03-146-14
 to
V03-146-25



Tissue Forceps, Dissecting Forceps

Chirurgische Pinzetten, Anatomische Pinzetten
 Pinzas de disección con diente, Pinzas de disección
 Pincers à dissection à griffes, Pincers à dissection
 Pinze per dissezione con denti, Pinze per dissezione



TC GOLD

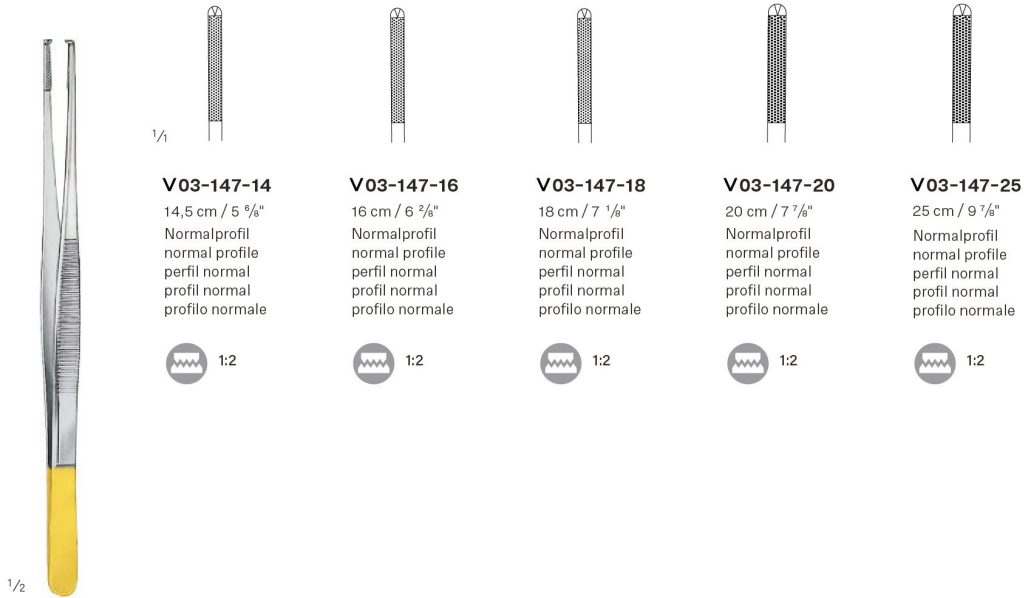

V03-147-14
 14,5 cm / 5 9/16"
 Normalprofil
 normal profile
 perfil normal
 profil normal
 profilo normale



V03-147-16
 16 cm / 6 2/8"
 Normalprofil
 normal profile
 perfil normal
 profil normal
 profilo normale



V03-147-18
 18 cm / 7 1/8"
 Normalprofil
 normal profile
 perfil normal
 profil normal
 profilo normale

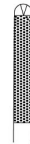

V03-147-20
 20 cm / 7 7/8"
 Normalprofil
 normal profile
 perfil normal
 profil normal
 profilo normale

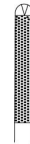

V03-147-25
 25 cm / 9 7/8"
 Normalprofil
 normal profile
 perfil normal
 profil normal
 profilo normale



1/2
Oehler
V03-147-14
 to
V03-147-25

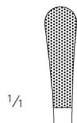

V03-148-15
 15 cm / 5 7/8"
 Normalprofil
 normal profile
 perfil normal
 profil normal
 profilo normale

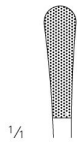

V03-148-23
 23 cm / 9"
 Normalprofil
 normal profile
 perfil normal
 profil normal
 profilo normale

1/2
Wangenstein
V03-148-15
V03-148-23



Dissecting Forceps
 Anatomische Pinzetten
 Pinzas de disección
 Pincès à dissection
 Pinze per dissezione

TC GOLD
Atrauma



1/2

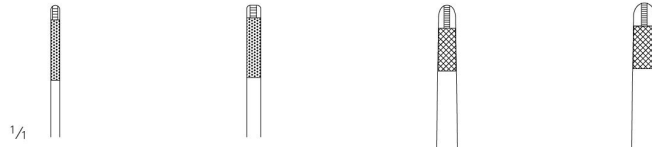

	Miniprofil mini profile perfil mini profil mini mini-profilo	Miniprofil mini profile perfil mini profil mini mini-profilo	Normalprofil normal profile perfil normal profil normal profilo normale	Normalprofil normal profile perfil normal profil normal profilo normale
	1,5 mm	2,0 mm	2,7 mm	3,5 mm
16 cm / 6 2/8"	V03-149-16	V03-150-16	V03-151-16	V03-152-16
20 cm / 7 7/8"	V03-149-20	V03-150-20	V03-151-20	V03-152-20
24,5 cm / 9 5/8"	V03-149-24	V03-150-24	V03-151-24	V03-152-24

DeBakey
V03-149-16
 to
V03-152-24



1/2

Jaboma
V03-153-18
 18 cm / 7 1/8"



1/2

Jaboma
V03-154-18
 18 cm / 7 1/8"



1/2

Jaboma
V03-155-18
 18 cm / 7 1/8"



Dissecting Forceps, Atraumatic Dissecting Forceps
 Anatomische Pinzetten, Atraumatische Pinzetten
 Pinzas de disección, Pinzas de disección atraumática
 Pincès à dissection, Pincès atraumatiques à dissection
 Pinze per dissezione, Pinze atraumatiche



1/2

DeBakey
 V03-156-16

Atrauma

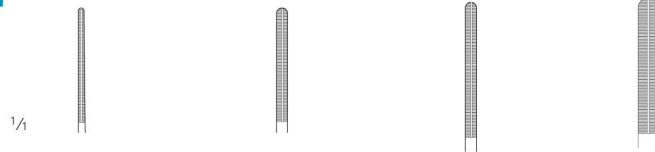

	1,0 mm	1,5 mm	1,8 mm	2,8 mm
16 cm / 6 2/8"	V03-156-16	V03-157-16	V03-158-16	V03-159-16
20,5 cm / 8 1/8"	V03-156-20	V03-157-20	V03-158-20	V03-159-20
24,5 cm / 9 5/8"	V03-156-24	V03-157-24	V03-158-24	V03-159-24



1/2

Gerald
 V03-160-18
 to
 V03-165-20



	Atrauma	diamond	diamond
	1,2 mm	1,0 x 0,5 mm	1,0 mm
18 cm / 7 1/8"	V03-160-18	V03-161-18	V03-162-18
18 cm / 7 1/8"	V03-163-18	V03-164-18	V03-165-18
20 cm / 7 7/8"	V03-160-20	V03-161-20	V03-162-20
20 cm / 7 7/8"	V03-163-20	V03-164-20	V03-165-20

Tissue Forceps

Chirurgische Pinzetten
 Pinzas de disección con diente
 Pinces à dissection à griffes
 Pinze per dissezione con denti



1/2

V03-166-10 to V03-166-30
 Standardmodell
 standard pattern
 modelo estándar
 modèle standard
 modello standard



1/2

V03-167-12 to V03-167-25

V03-166-10 10,5 cm / 4 1/8"	V03-166-12 12 cm / 4 5/8"	V03-166-13 13 cm / 5 1/8"	V03-166-14 14,5 cm / 5 5/8"	V03-166-16 16 cm / 6 2/8"
1:2	1:2	1:2	1:2	1:2
V03-166-18 18 cm / 7 1/8"	V03-166-20 20,5 cm / 8 1/8"	V03-166-23 23 cm / 9"	V03-166-25 25 cm / 9 7/8"	V03-166-30 30,5 cm / 12"
1:2	1:2	1:2	1:2	1:2
V03-167-12 12 cm / 4 5/8"	V03-167-13 13 cm / 5 1/8"	V03-167-14 14,5 cm / 5 5/8"	V03-167-16 16 cm / 6 2/8"	
2:3	2:3	2:3	2:3	
V03-167-17 17 cm / 6 5/8"	V03-167-18 18 cm / 7 1/8"	V03-167-20 20,5 cm / 8 1/8"	V03-167-25 25 cm / 9 7/8"	
2:3	2:3	2:3	2:3	



Tissue Forceps

Chirurgische Pinzetten
 Pinzas de disección con diente
 Pincers à dissection à griffes
 Pinze per dissezione con denti



1/2

V03-168-14
 14,5 cm / 5 9/16"

V03-168-16
 16 cm / 6 2/8"

V03-168-20
 20 cm / 7 7/8"

V03-169-14
 14,5 cm / 5 9/16"

V03-169-16
 16 cm / 6 2/8"

1/4

1/4

1/4

1/4

1/4

1/4

V03-168-14 to V03-168-20

V03-169-14 to V03-169-16



1/2

V03-170-13
 13 cm / 5 1/8"

V03-170-14
 14,5 cm / 5 9/16"

V03-170-16
 16 cm / 6 2/8"

V03-170-18
 18 cm / 7 1/8"

1/4

1/4

1/4

1/4

V03-170-20
 20,5 cm / 8 1/8"

V03-170-23
 23 cm / 9"

V03-170-25
 25 cm / 9 7/8"

V03-170-30
 30 cm / 11 9/16"

1/4

1/4

1/4

1/4

V03-170-13 to V03-170-30
 mittelbreit
 medium
 medio
 moyen
 medio

Tissue Forceps

Chirurgische Pinzetten
 Pinzas de disección con diente
 Pinces à dissection à griffes
 Pinze per dissezione con denti

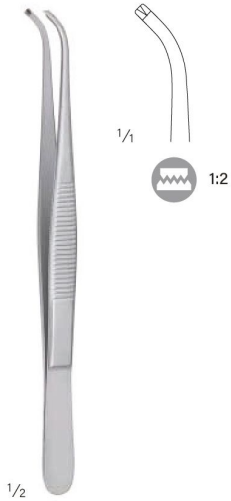

V03-171-14
 14,5 cm / 5 9/16"



V03-172-13
V03-172-14

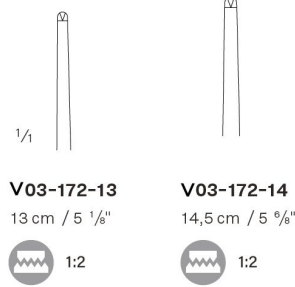

V03-172-13
 13 cm / 5 1/8"

V03-172-14
 14,5 cm / 5 9/16"



Stille
V03-173-15
V03-174-15
 15 cm / 5 7/8"

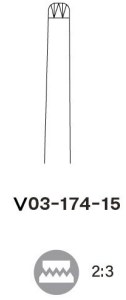

V03-174-15



Adlerkreutz
V03-175-15
 to
V03-179-25

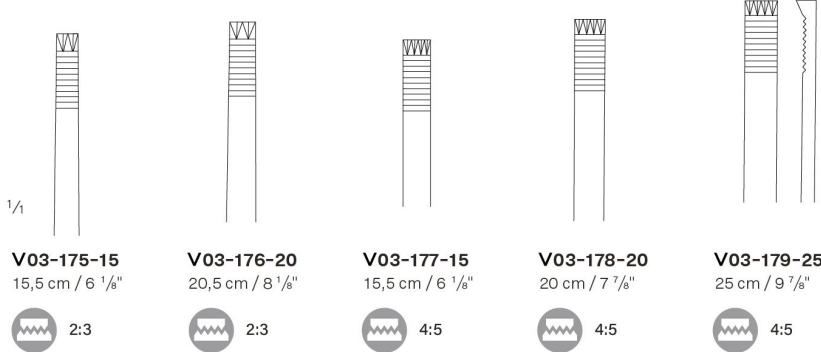

V03-175-15
 15,5 cm / 6 1/8"

2:3

V03-176-20
 20,5 cm / 8 1/8"

2:3

V03-177-15
 15,5 cm / 6 1/8"

4:5

V03-178-20
 20 cm / 7 7/8"

4:5

V03-179-25
 25 cm / 9 7/8"

4:5

Tissue Forceps

Chirurgische Pinzetten
Pinzas de disección con diente
Pincès à dissection à griffes
Pinze per dissezione con denti



V03-180-12
12 cm / 4 7/8"

V03-180-15
15 cm / 5 7/8"

Adson
V03-180-12
V03-180-15



Gillies
V03-181-15
15,5 cm / 6 1/8"



V03-182-20
20 cm / 7 7/8"

V03-182-25
25 cm / 9 7/8"

Waugh
V03-182-20
V03-182-25



V03-183-12
12,5 cm / 4 7/8"

V03-183-15
15 cm / 5 7/8"

Semken
V03-183-12
V03-183-15

Tissue Forceps, Dissecting Forceps

Chirurgische Pinzetten, Anatomische Pinzetten
 Pinzas de disección con diente, Pinzas de disección
 Pincas à dissection à griffes, Pincas à dissection
 Pinze per dissezione con denti, Pinze per dissezione



Brophy
V03-184-20
 20 cm / 7 7/8"

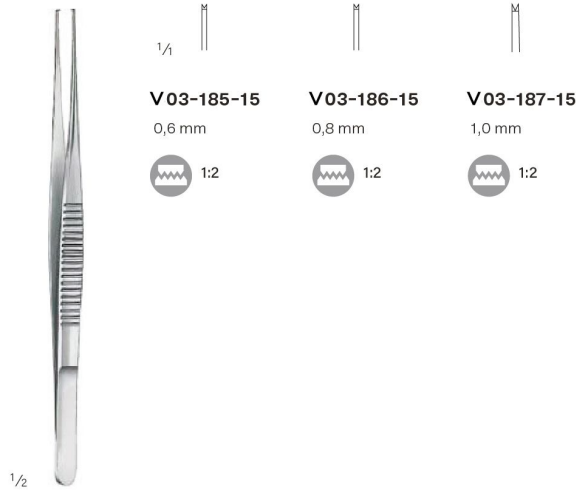

V03-185-15
 0,6 mm
V03-186-15
 0,8 mm
V03-187-15
 1,0 mm



Taylor
V03-188-17
 17,5 cm / 6 7/8"



Taylor
V03-189-17
 17 cm / 6 5/8"
 mit Schaberende
 with dissector end
 con rascador
 à rugine
 con estremita a forma di raschino



Taylor
V03-190-18
 18,5 cm / 7 2/8"
 mit Schaberende
 with dissector end
 con rascador
 à rugine
 con estremita a forma di raschino



Tissue Forceps

Chirurgische Pinzetten
Pinzas de disección con diente
Pincers à dissection à griffes
Pinze per dissezione con denti



1/2

Gerald
V03-191-17
V03-193-17



1/1

V03-191-17
17,5 cm / 6 7/8"



1:2



V03-192-23
23 cm / 9"



1:2



V03-193-17
17 cm / 6 5/8"



1:2



1/2

Cushing
V03-194-18
18 cm / 7 1/8"



1/1



1:2



1/2

Potts-Smith
V03-195-18
to
V03-195-30



1/1

V03-195-18
18 cm / 7 1/8"



1:2



V03-195-21
21 cm / 8 2/8"



1:2



V03-195-25
25 cm / 9 7/8"



1:2



V03-195-30
30 cm / 11 5/8"



1:2

Dissecting Forceps, Tissue Forceps

Anatomische Pinzetten, Chirurgische Pinzetten
 Pinzas de disección, Pinzas de disección con diente
 Pincas à dissection, Pincas à dissection à griffes

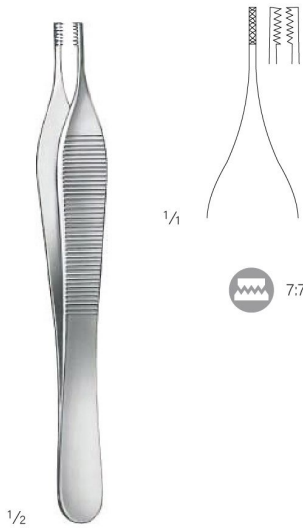

Adson-Brown
V03-196-12
 12 cm / 4 5/8"

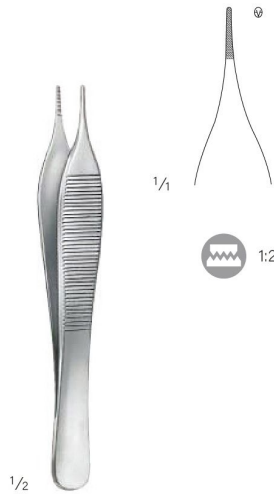

Mini-Adson
V03-197-12
 12 cm / 4 5/8"

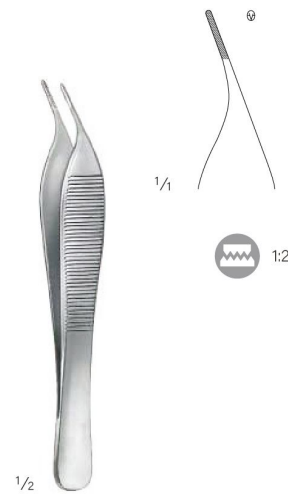

Mini-Adson
V03-198-12
 12 cm / 4 5/8"



Mikro-Adson
V03-199-12
V03-199-15



V03-199-15
 15 cm / 5 7/8"



Mikro-Adson
V03-200-12
V03-200-15

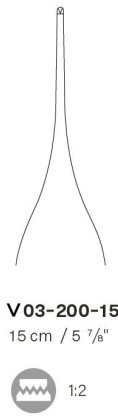

V03-200-15
 15 cm / 5 7/8"

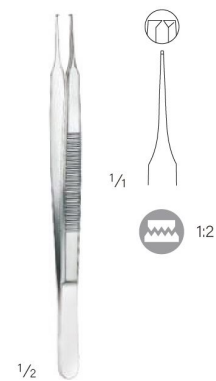

V03-201-10
 10,5 cm / 4 1/8"
 sehr feine Zähne
 very fine teeth
 dientes muy finos
 dents très fines
 denti molto fini

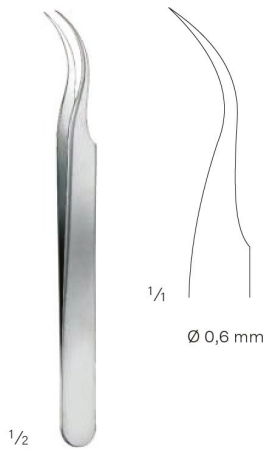

V03-202-12
 12 cm / 4 5/8"
 Fig. 7

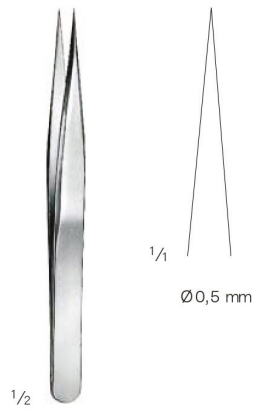

V03-203-12
 12 cm / 4 5/8"
 Fig. 3

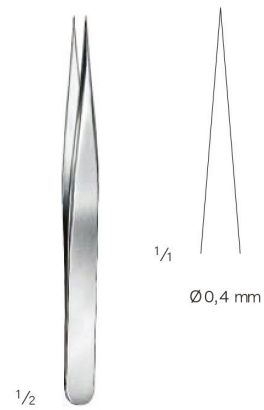

V03-204-11
 11 cm / 4 3/8"
 Fig. 3 C

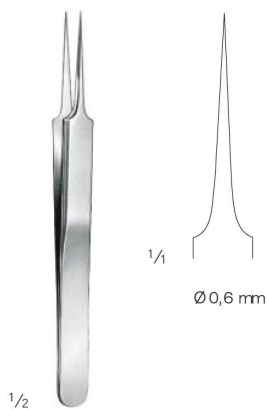

V03-205-11
 11 cm / 4 3/8"
 Fig. 5

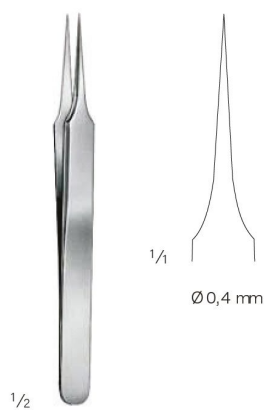

V03-206-11
 11 cm / 4 3/8"
 Fig. 4

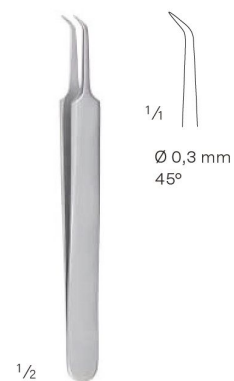

V03-207-11
 11 cm / 4 3/8"

Tissue Forceps

Chirurgische Pinzetten
 Pinzas de disección con diente
 Pincès à dissection à griffes
 Pinze per dissezione con denti

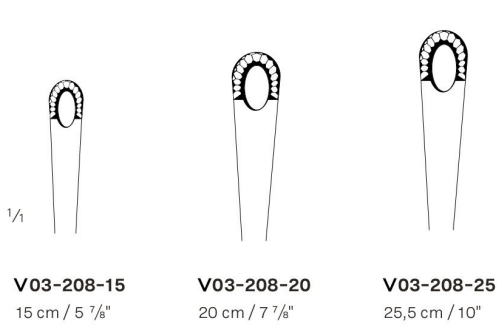

V03-208-15
15 cm / 5 7/8"

V03-208-20
20 cm / 7 7/8"

V03-208-25
25,5 cm / 10"

1/2

Russ. Modell

V03-208-15
to
V03-208-25

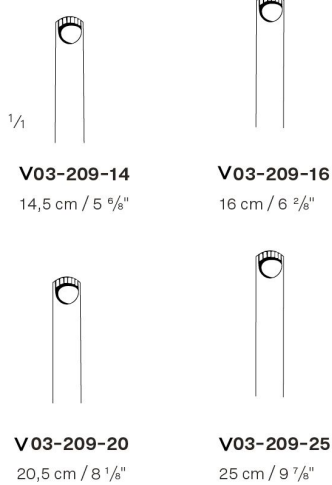

V03-209-14
14,5 cm / 5 9/8"

V03-209-16
16 cm / 6 2/8"

V03-209-20
20,5 cm / 8 1/8"

V03-209-25
25 cm / 9 7/8"

1/2

Durante
V03-209-14
to
V03-209-25

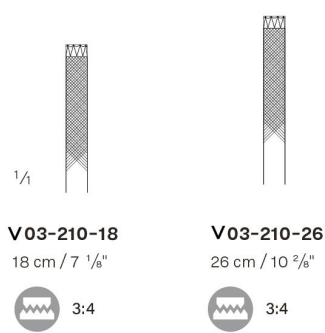

V03-210-18
18 cm / 7 1/8"

V03-210-26
26 cm / 10 2/8"



1/2

Stille-Barraya
V03-210-18
V03-210-26



Tissue Forceps, Dissecting Forceps

Chirurgische Pinzetten, Anatomische Pinzetter
Pinzas de disección con diente, Pinzas de disección
Pincas à dissection à griffes, Pincas à dissection
Pinze per dissezione con denti, Pinze per dissezione

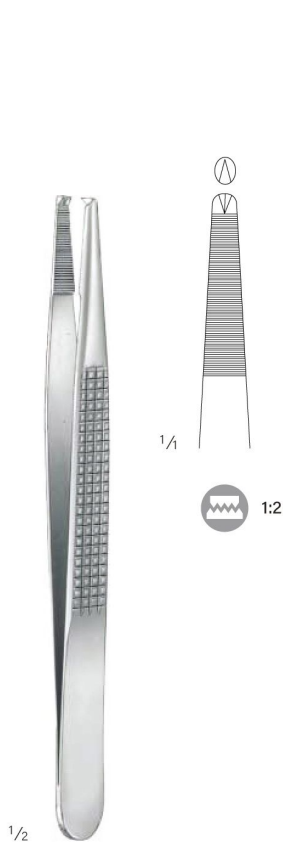

Bonney
V03-211-17
17,5 cm / 6 7/8"



Mayo
V03-212-23
23 cm / 9"



Singley-Tuttle
V03-213-18
18 cm / 7 1/8"



Singley-Tuttle
V03-214-23
23 cm / 9"



Tissue Forceps

Chirurgische Pinzetten
Pinzas de disección con diente
Pinces à dissection à griffes
Pinze per dissezione con denti



Nelson
V03-215-23
23 cm / 9"



Resano
V03-216-23
23 cm / 9"

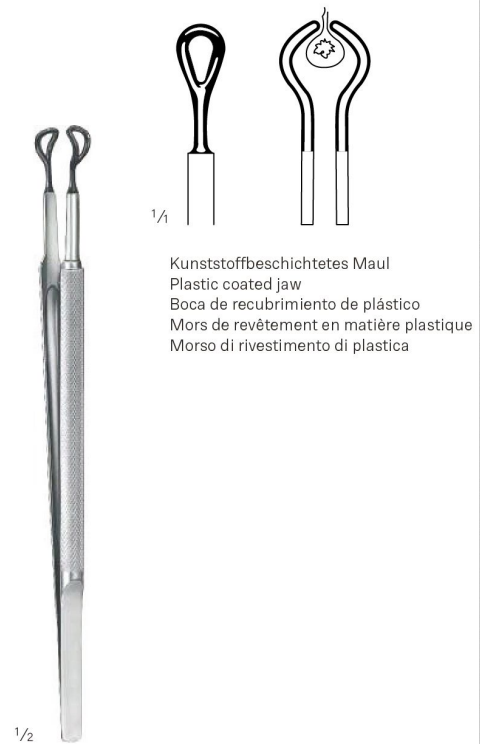

Hepp-Scheidel
V03-217-18
18 cm / 7 1/8"
Tubenfasspinzette
Tubal forceps
Pinza para tubos
Pince pour saisir les trompes
pinza oer afferare tubi

Kunststoffbeschichtetes Maul
Plastic coated jaw
Boca de recubrimiento de plástico
Mors de revêtement en matière plastique
Morso di rivestimento di plastica



Dissecting Forceps, Tissue Forceps
 Anatomische Pinzetten, Chirurgische Pinzetten
 Pinzas de disección, Pinzas de disección con diente
 Pincas à dissection, Pincas à dissection à griffes



1/2

V03-218-10
 to
V03-223-09
 fein
 delicate
 fino
 fin
 fino



1/1

V03-218-10
 10 cm / 3 7/8"



V03-219-10
 10 cm / 3 7/8"



V03-220-09
 9,5 cm / 3 5/8"



V03-221-10
 10 cm / 3 7/8"



1:2



V03-222-10
 10 cm / 3 7/8"



1:2



V03-223-09
 9,5 cm / 3 5/8"



1:2

Short Micro Forceps
 Kurze Mikropinzetten
 Micro Pinzas, corto
 Micro-Pinces, court
 Micro-Pinze, corto



1/2
V03-224-01
 to
V03-225-03
 11 cm / 4 3/8"



1/2
V03-224-07
 to
V03-225-06
 11 cm / 4 3/8"

1/4			
Ø	0.15 mm	0.20 mm	0.30 mm
St	V03-224-01	V03-224-02	V03-224-03
1/4			
Ø	0.50 mm	1.2 mm	
St	V03-225-01	V03-225-02	V03-225-03
1/4			
	VD	VD	VD
Ø	0.10 mm	0.20 mm	0.30 mm
gewinkelt/angled/ acodada/angulée/ angolata	10°	10°	10°
St	V03-224-04	V03-224-05	V03-224-06
1/4			
Ø	0.15 mm	0.20 mm	0.30 mm
St	V03-224-07	V03-224-08	V03-224-09
1/4			
Ø	0.50 mm	1.2 mm	
St	V03-225-04	V03-225-05	V03-225-06
1/4			
	VD	VD	VD
Ø	0.10 mm	0.20 mm	0.30 mm
gewinkelt/angled/ acodada/angulée/ angolata	10°	10°	10°
St	V03-224-10	V03-224-11	V03-224-12



Micro Forceps, Micro dilating forceps
 Mikropinzetten, Gefäß-Dilatationspinzetten
 Micro Pinzas, Micro pinza de dilatación
 Micro-Pinces, Micro pince à dilater
 Micro-Pinze, Micro pinze per dilatazione



1/2

Jeweler mod.
V03-226-11
 to
V03-231-13

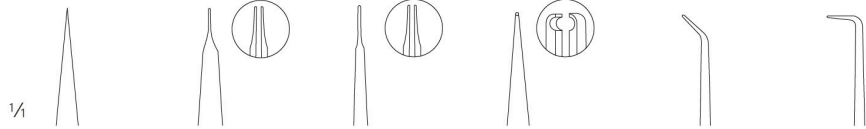

		VD	VD	Pierse	45°	90°	
11 cm / 4 3/8"	Ø 0.30 mm	0.20 mm	0.30 mm	0.30 mm	0.30 mm	0.30 mm	
	St	V03-226-11	V03-227-11	V03-228-11	V03-229-11	V03-230-11	V03-231-11
13,5 cm / 5 3/8"	St	V03-226-13	V03-227-13	V03-228-13	V03-229-13	V03-230-13	V03-231-13



1/2

V03-232-15
 to
V03-237-18



			45°		VD	Pierse	
15 cm / 5 7/8"	Ø 0.30 mm	0.30 mm	0.30 mm	1.0 x 0.5 mm	0.30 mm	0.30 mm	
	St	V03-232-15	V03-233-15	V03-234-15	V03-235-15	V03-236-15	V03-237-15
18 cm / 7 1/8"	St	V03-232-18	V03-233-18	V03-234-18	V03-235-18	V03-236-18	V03-237-18

Micro Forceps, Micro dilating forceps
 Mikropinzetten, Gefäß-Dilatationspinzetten
 Micro Pinzas, Micro pinza de dilatación
 Micro-Pinces, Micro pince à dilater
 Micro-Pinze, Micro pinze per dilatazione



1/2

V 03-238-15
 to
V 03-245-25

	diamond-coated	1/1						
		Ø	0.40 mm	0.40 mm	0.70 mm	0.70 mm	0.80 mm	0.80 mm
15 cm / 5 7/8"	St		V 03-238-15	V 03-298-15	V 03-240-15	V 03-241-15		
15 cm / 5 7/8"	Ti		V 03-242-15	V 03-243-15			V 03-244-15	V 03-245-15
18 cm / 7 1/8"	St		V 03-238-18	V 03-298-18	V 03-240-18	V 03-241-18		
18 cm / 7 1/8"	Ti		V 03-242-18	V 03-243-18			V 03-244-18	V 03-245-18
21 cm / 8 2/8"	St				V 03-240-21	V 03-241-21		
21 cm / 8 2/8"	Ti						V 03-244-21	V 03-245-21
23 cm / 9"	St				V 03-240-23	V 03-241-23		
23 cm / 9"	Ti						V 03-244-23	V 03-245-23
25 cm / 9 7/8"	St				V 03-240-25	V 03-241-25		
25 cm / 9 7/8"	Ti						V 03-244-25	V 03-245-25



1/2

V 03-246-15
 to
V 03-251-18

	diamond-coated	1/1						
		Ø	0.30 mm	0.30 mm	45°	1.0 x 0.5 mm	VD	Pierse
15 cm / 5 7/8"	St		V 03-246-15	V 03-247-15	V 03-248-15	V 03-249-15	V 03-250-15	V 03-251-15
18 cm / 7 1/8"	St		V 03-246-18	V 03-247-18	V 03-248-18	V 03-249-18	V 03-250-18	V 03-251-18



Micro Forceps
 Mikropinzetten
 Micro Pinzas
 Micro-Pinces
 Micro-Pinze



1/2

V03-252-18
 to
V03-255-25

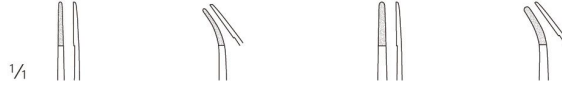
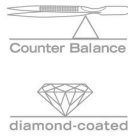

	Ø	0.40 mm	0.40 mm	0.70 mm	0.70 mm
18 cm / 7 1/8"	St	V03-252-18	V03-253-18	V03-254-18	V03-255-18
21 cm / 8 2/8"	St			V03-254-21	V03-255-21
23 cm / 9"	St			V03-254-23	V03-255-23
25 cm / 9 7/8"	St			V03-254-25	V03-255-25



1/2

V03-256-18
 to
V03-261-25



	Ø	1.0 x 0.5 mm	1.0 x 0.5 mm	1.0 x 0.5 mm	2.0 x 1.0 mm	2.0 x 1.0 mm	Atrauma
18 cm / 7 1/8"	St	V03-256-18	V03-257-18	V03-258-18	V03-259-18	V03-260-18	V03-261-18
21 cm / 8 2/8"	St	V03-256-21	V03-257-21	V03-258-21	V03-259-21	V03-260-21	V03-261-21
23 cm / 9"	St	V03-256-23	V03-257-23	V03-258-23	V03-259-23	V03-260-23	V03-261-23
25 cm / 9 7/8"	St	V03-256-25	V03-257-25	V03-258-25	V03-259-25	V03-260-25	V03-261-25

Micro Forceps
 Mikropinzetten
 Micro Pinzas
 Micro-Pinces
 Micro-Pinze



1/2

V03-262-15
 to
V03-269-21



	mm	1:2	1:2	1:2	1:2	1:2	1:2
	Ø	0.40 mm	0.40 mm	0.70 mm	0.70 mm	0.80 mm	0.80 mm
15 cm / 5 7/8"	St	V03-262-15	V03-263-15	V03-264-15	V03-265-15		
15 cm / 5 7/8"	Ti	V03-266-15	V03-267-15			V03-268-15	V03-269-15
18 cm / 7 1/8"	St	V03-262-18	V03-263-18	V03-264-18	V03-265-18		
18 cm / 7 1/8"	Ti	V03-266-18	V03-267-18			V03-268-18	V03-269-18
21 cm / 8 2/8"	St			V03-264-21	V03-265-21		
21 cm / 8 2/8"	Ti					V03-268-21	V03-269-21
23 cm / 9"	St			V03-264-23	V03-265-23		



1/2

V03-266-15
 to
V03-277-25



	Ø	1.0 x 0.5 mm	1.0 x 0.5 mm	1.0 x 0.5 mm	2.0 x 1.0 mm	2.0 x 1.0 mm	Atrauma
15 cm / 5 7/8"	St	V03-266-15	V03-267-15	V03-268-15	V03-269-15	V03-270-15	V03-271-15
15 cm / 5 7/8"	Ti	V03-272-15	V03-273-15	V03-274-15	V03-275-15	V03-276-15	V03-277-15
18 cm / 7 1/8"	St	V03-266-18	V03-267-18	V03-268-18	V03-269-18	V03-270-18	V03-271-18
18 cm / 7 1/8"	Ti	V03-272-18	V03-273-18	V03-274-18	V03-275-18	V03-276-18	V03-277-18
21 cm / 8 2/8"	St	V03-266-21	V03-267-21	V03-268-21	V03-269-21	V03-270-21	V03-271-21
21 cm / 8 2/8"	Ti	V03-272-21	V03-273-21	V03-274-21	V03-275-21	V03-276-21	V03-277-21
23 cm / 9"	St	V03-266-23	V03-267-23	V03-268-23	V03-269-23	V03-270-23	V03-271-23
23 cm / 9"	Ti	V03-272-23	V03-273-23	V03-274-23	V03-275-23	V03-276-23	V03-277-23
25 cm / 9 7/8"	St	V03-266-25	V03-267-25	V03-268-25	V03-269-25	V03-270-25	V03-271-25
25 cm / 9 7/8"	Ti	V03-272-25	V03-273-25	V03-274-25	V03-275-25	V03-276-25	V03-277-25



Splinter Forceps

Splitterpinzetten
Pinzas para espinas
Pincas à échardes
Pinze per scheggie

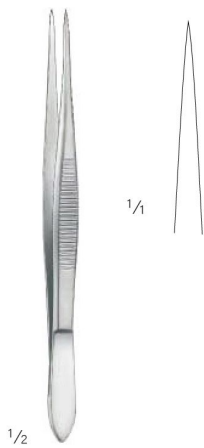

V03-278-12

12,5 cm / 4 7/8"
glattes Maul
smooth jaw
boca lisa
mors lisse
morso liscio

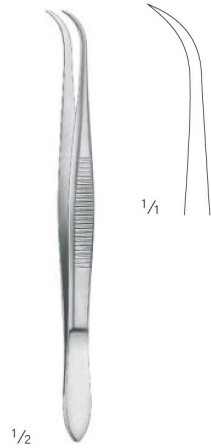

V03-279-12

12,5 cm / 4 7/8"
glattes Maul
smooth jaw
boca lisa
mors lisse
morso liscio



V03-280-09

9 cm / 3 4/8"



V03-280-10

10,5 cm / 4 1/8"



V03-280-12

12,5 cm / 4 7/8"



V03-281-09

9 cm / 3 4/8"

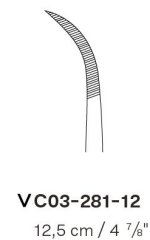

VC03-281-12

12,5 cm / 4 7/8"

V03-280-09 to V03-280-12

gerieftes Maul
serrated jaw
boca estriada
mors strié
morso striato

V03-281-09 V03-281-12

gerieftes Maul
serrated jaw
boca estriada
mors strié
morso striato



Splinter Forceps

Splinterpinzetten
Pinzas para espinas
Pincas à échardes
Pinze per scheggie



V03-282-15
15,5 cm / 6 1/8"

Mikro-Knüpfpinzette, glattes Maul
Micro Tying Forceps, smooth jaw
Micro Pinza para anudar, boca lisa
Micro-Pince à poser des ligatures, mors lisse
Micro-Pinza per legature, morso liscio



Lazar
V03-283-15
V03-284-15
15,5 cm / 6 1/8"

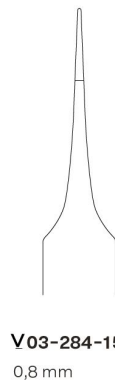
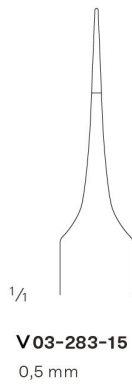

V03-285-12
12 cm / 5 1/8"

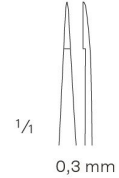

Austin
V03-286-14
14 cm / 5 4/8"



Feilchenfeld
V03-287-07
to
V03-287-11

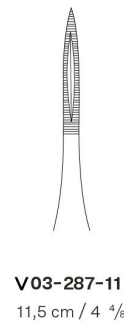
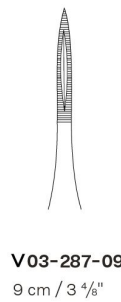
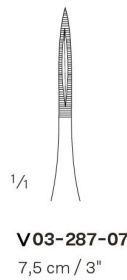

Splinter Forceps, Microscopic Forceps

Splitterpinzetten, Mikroskopierpinzetten
Pinzas para espinas, Pinzas para microscopias
Pinces à écharde, Pinces à microscopies
Pinze per scheggie, Pinze per microscopie



1/2



1/4

V03-288-10
10,5 cm / 4 1/8"



V03-289-10
10,5 cm / 4 1/8"



1/2



1/4

V03-290-10
10 cm / 3 7/8"



1/2



1/4

V03-291-10
10 cm / 3 7/8"



1/2

V03-292-10
10 cm / 3 7/8"

Mikroskopierpinzette, superleicht, stumpf
Microscopic Forceps, super light, blunt
Pinza para microscopía, super ligero, roma
Pince à microscopie, très légère, mousse
Pinza per microscopia, molto leggera, smussa



1/2

V03-293-10
10 cm / 3 7/8"

Mikroskopierpinzette, superleicht, spitz
Microscopic Forceps, super light, sharp
Pinza para microscopía, super ligero, puntiaguda
Pince à microscopie, très légère, pointue
Pinza per microscopia, molto leggera, appuntata



1/2



1/4

Shaaf
V03-294-09
9,5 cm / 3 6/8"

Cilia Forceps

Cilienpinzetten
Pinzas depilatorias
Pincas à épiler les cils
Pinze depilatoria

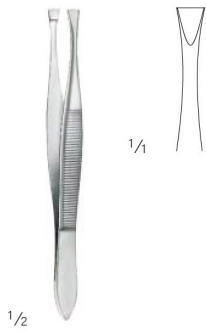

Littauer

V03-295-08

8,5 cm / 3 3/8"

glattes Maul
smooth jaw
boca lisa
mors lisse
morso liscio

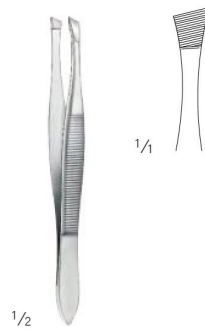

V03-296-09

9 cm / 3 4/8"

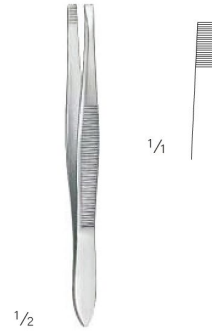

Douglas

V03-297-09

9 cm / 3 3/8"

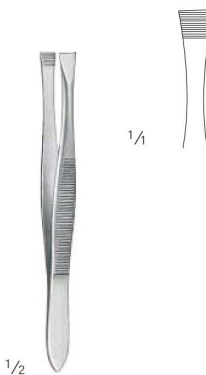

Douglas

V03-298-09

9 cm / 3 4/8"

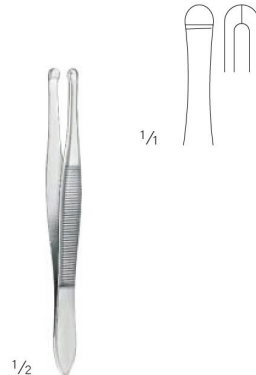

Beer

V03-299-09

9 cm / 3 4/8"

glattes Maul
smooth jaw
boca lisa
mors lisse
morso liscio

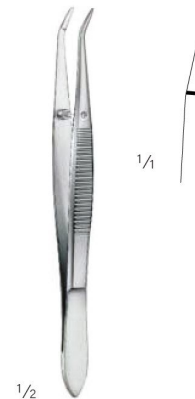

Barraquer

V03-300-11

11 cm / 4 3/8"

glattes Maul
smooth jaw
boca lisa
mors lisse
morso liscio

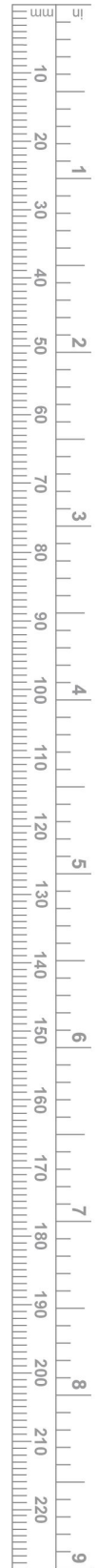

Splinter Forceps
Splitterpinzetten
Pinzas para espinas
Pinces à échardes
Pinze per scheggie



1/1

V03-301-14
14 cm / 5 1/8"

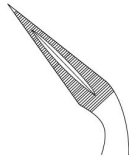

V03-301-13
13,5 cm / 5 3/8"

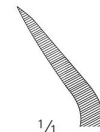

1/1



1/2

Peet
V03-302-12
12,5 cm / 4 7/8"



1/1

V03-303-15
15 cm / 5 7/8"

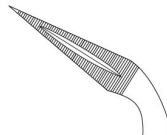

V03-303-14
14 cm / 5 4/8"

1/2

Ralk
V03-303-15
V03-303-14



no one does it BETTER



Cell: +92 334 6113800

URL: <https://vorlinginstruments.com>

Email: info@vorlinginstruments.com

Address:

Kacha Shahab Pura Road

Jeewan Pura, Sialkot (51310)

Pakistan.

